

CATALOG

Products and Solutions

2017

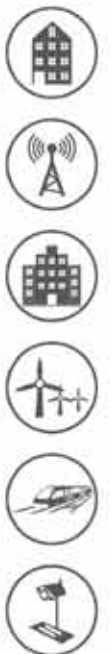



RAISECOM

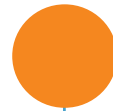

About Raisecom

Raisecom, established in 1999, is now a leading vendor providing comprehensive access solutions and network devices. Headquartered in Beijing (China), Raisecom has consistently achieved strong growth with partners and customers over 80 countries worldwide.

Aiming at offering the best connectivity for service providers, power & utilities, transportation, government and enterprises, Raisecom has been expanding its offerings in the last 17 years. Raisecom has over 2,000 employees with one RnD center in Beijing, two main manufacturing sites in Beijing and Shenzhen, eleven international branches and representative offices, and Raisecom Inc. located in Florida, USA.

Starting from innovative Ethernet media converters, Raisecom has developed a number of product lines including Carrier Ethernet, IP MPLS, Optical Transport Network, Packet Transport Network, xPON, SME Routers, Industrial Networking Solutions, PCM for SCADA, Ethernet Over Everything, Multi-Service Last Mile Access and NMS. In addition, we specialize in tailored solutions for access scenarios focusing on service providers, mobile backhaul and front haul, broadband access, mission critical networks, enterprise and government communications services.

Additionally Raisecom is offering SDN and NFV Networking and Communications solutions, following the global trend of virtualizing communications functionalities.

Raisecom is ISO9001:2008 certified for RnD, manufacturing, technical support and marketing. Our products are compliant with CE, RoHS, IEEE, IEC, UL and CSA standards and regulatory. Raisecom is a member of Syncworld ecosystem. We also participate and sponsor top-level industry exhibitions, conferences and forums. The company has been recognized as part of the "Top 10 Competitiveness Enterprises in the Optical Transmission and Network Access Equipment Field of China".

We are also among the market-leading Carrier Ethernet manufactures, and received prestige awards from global organizations, among them Metro Ethernet Forum.



Solutions

Service Providers	4
Mobile	9
Broadband Access	13
Mission Critical Networks	17
Enterprise and Government	22

01

Carrier Ethernet

Ethernet Demarcation Device.....	27
SDN-Enabled Ethernet Demarcation Device.....	28
Carrier Ethernet Switch.....	28
L2 Manageable Full Gigabit Access Switch.....	29
L2 Carrier-Grade FE Access Switch.....	30
Carrier-Grade L2 Access PoE Switch.....	31
L2&L3 Aggregation Switch.....	32

02

IP MPLS

IP-MPLS PE and Pre-Aggregation Product.....	33
IP-MPLS CPE Product.....	34

03

Optical Transport Network

Multi-Service OTN Platform.....	35
---------------------------------	-----------

04

Packet Transport Network

Dual-Core Architecture PTN Aggregation Platform.....	37
Compact PTN Aggregation Platform.....	38
TDM over Ethernet/IP/MPLS.....	39

05

xPON

XPON OLT.....	41
EPON OLT.....	42
Standalone EPON OLT.....	43
EPON ONU.....	44
EPON MDU.....	44
Standalone GPON OLT.....	45
GPON ONT.....	46
PON Extender.....	47
CATV EDFA.....	47
Splitter.....	48



06

SME Router

High Security Data Access for SME	48
Data and VoIP for SOHO/Home.....	49
Integrated Access Devices	49

07

Industrial Switch

L2 DIN-Rail Manageable Industrial Switch	50
L2/L3 19" Full Gigabit Manageable Industrial Switch	51
L2 Manageable EN50155 Industrial Switch.....	52
DIN Rail 3G/4G Router	52

08

PCM for SCADA

Multi-Service Chassis	53
Multi-Service Terminal Mux.....	54

09

Ethernet over Everything

Ethernet over Fiber	55
Ethernet over PDH	56
Ethernet over Copper (SHDSL.bis)	56

10

Multi-Service Last Mile Access

SDH ADM	57
Fiber Optical Transmission Device	57
Fiber Optical Modem.....	58
Multi-Service FiberMux.....	58
Multi-Service Modem Chassis.....	59
Single/Double-Slot Chassis	59

11

Network Management System

Topology Management	60
Inventory Management	61
Configuration Management	61
Fault Management	62
Customer Management	62
Performance Management	62
Security Management	63
Web Management	63
Zero Touch Provisioning	63
SLA Portal	64



Service Providers

Raisecom telecommunications solutions present a comprehensive range of access solutions and technologies, targeting telecom service providers, large enterprises, financial institutions, government bodies, educational organizations, health centers, and other public establishments, where mission-critical tasks as well as conventional data communication are delivered and processed quickly.

Raisecom solutions enable services with assured bandwidth, guaranteed data security, minimized potential economic loss (due to network failures), and with the ability to deliver end-to-end Carrier-grade services with a reliable and pre-defined SLA. Since Raisecom solutions are part of a higher grade networks, the solutions enable highly resilient services with L2/L3 demarcation in a versatile access infrastructure. Access rates range from 2Mbps to sub-100Mbps, and up to 1Gbps and 10Gbps, meeting requests for highly adaptable, versatile, and incremental bandwidth.

Operators nowadays offer a variety of services, while attempting to maximize their infrastructure. Therefore, Raisecom provides flexible combinations of product solutions to assist combining state-of-the-art networking technologies with mobile networking implementation, end-to-end management and solution-enabling maintenance.

IP/MPLS Access and Pre-Aggregation Solution

- End-to-end service using MPLS technology
- Running L2/L3 VPN's over MPLS from the CPEs, Reducing the OPEX by simplifying the network routing and provisioning process
- Service Resiliency – End to End service protection, based on MPLS protection starting at the CPE level
- Transparent passing of end user traffic via MPLS VPN's (with no MAC learning)
- Multi Technology (CE/MPLS-TP/IP-MPLS) CPEs and Pre-Agg Device (both IP-MPLS and MPLS-TP stack)
- SLA assurance based on L2/L3 VPN's
- Built in Pseudowire (E1/STM-1/STM-4) and Clocking (Sync-E/1588v2) functionalities
- The solution enables service providers to improve their service responsiveness using state-of-the-art multi-purpose ISCOM RAX711/iTN201-R CPEs and iTN8800 (high scale cost effective IP-MPLS pre aggregator)

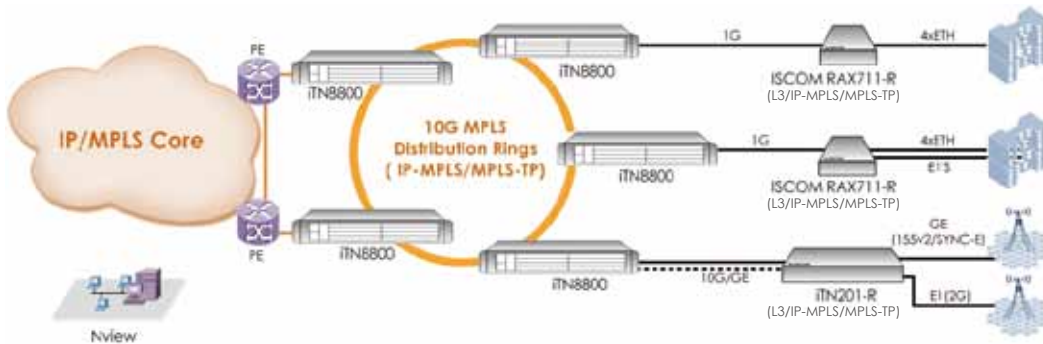

High Performance SLA-based Ethernet Business Services

- MFF CE2.0 based Ethernet and IP enterprise services over Access and Metro Rings (RFC-2544/Y.1564)
- Premium SLA services with L2/L3 performance monitoring and service activation tests
- Full protection to assure service reliability based on standard G.8031 and G.8032 linear and ring protection
- Building a complete access solution (10G/GE) for E-Line, E-LAN, E-Tree and E-Access allows service provider to deploy and deliver new service in a short period of time
- Increase offering value & reduce CapEx by adding TDM emulation service

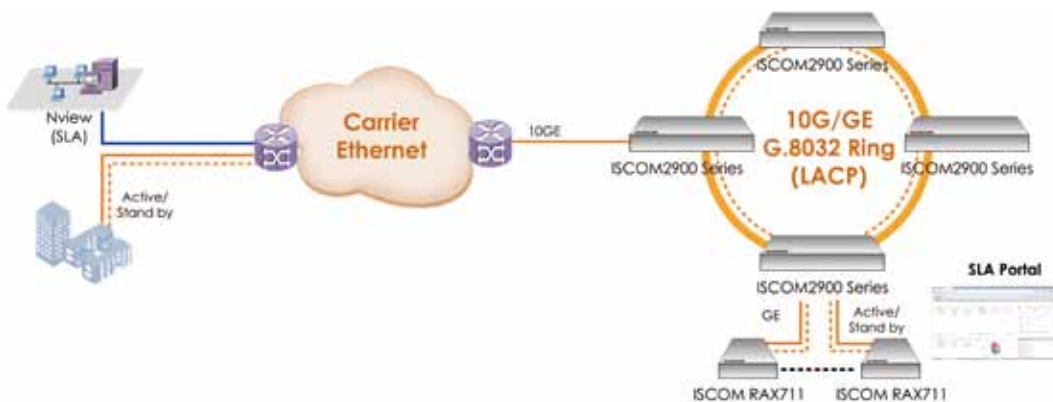

Performance Monitoring for Business VPNs

- Business-grade L2/L3 VPN services should be continuously monitored to assure SLA and performance
- VPNs performance can be validated by various means, e.g. In-service Y.1564 and TWAMP
- Raisecom's multi-technology demarcation CPEs enable performance monitoring and are also compatible with performance assuring and monitoring vendors solution from other vendors
- The solutions collect vast amount of detailed data which can be used for SLA reporting

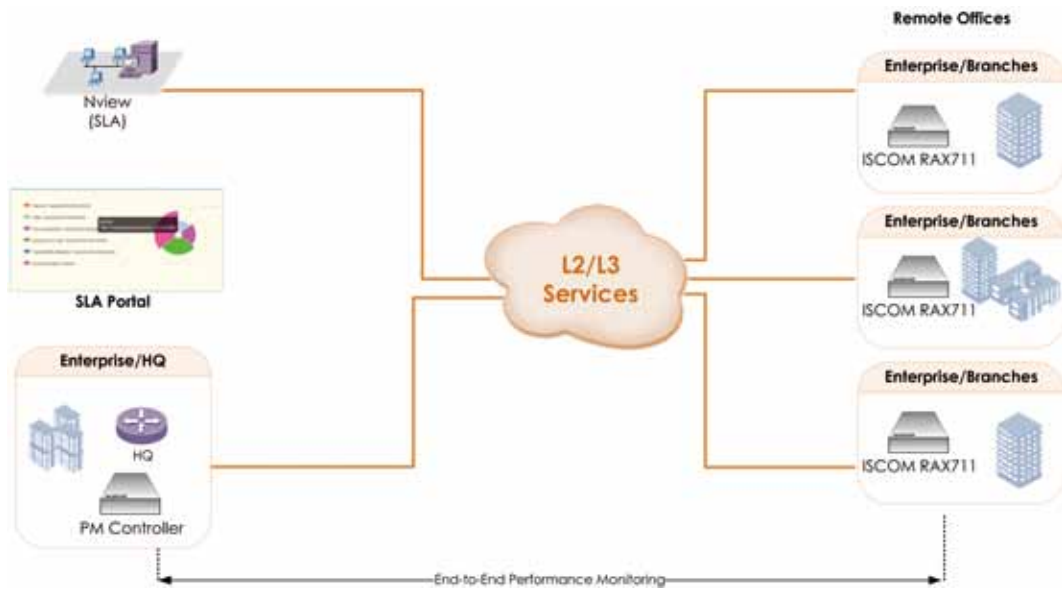

High Performance SLA-based Wholesale and Carrier of Carrier Ethernet Services

- MEF based wholesales Ethernet service offered to other service provider (Carrier of Carrier service)
- End-to-end SLA assurance based on MEF CE 2.0
- Compliant with MEF-33, E-ACCESS services for Multi carrier networks communication
- Multi service (Ethernet and E1) over 1G and 10G network interfaces

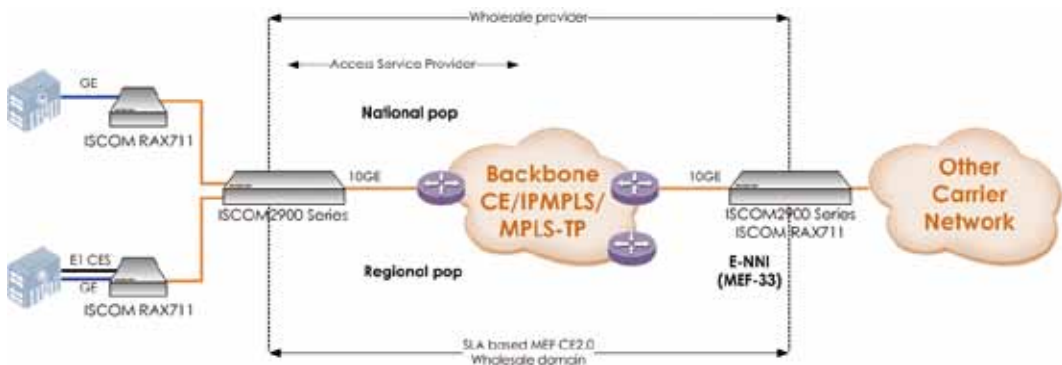

TDM Extension over Packet Network

- Service providers are still maintaining TDM services and networks
- Maintain revenue flow from legacy services and add new IP/Ethernet services
- Reduce churn by preserving legacy services
- Broad portfolio of scalable pseudowire solutions: CPEs, medium and large aggregators
- Flexibility of TDM emulated services: nx64, E1 up to Channelized STM-4
- Pseudowire services can be delivered over point to point and point to multi-point topologies
- Ensure timing synchronization over packet transport

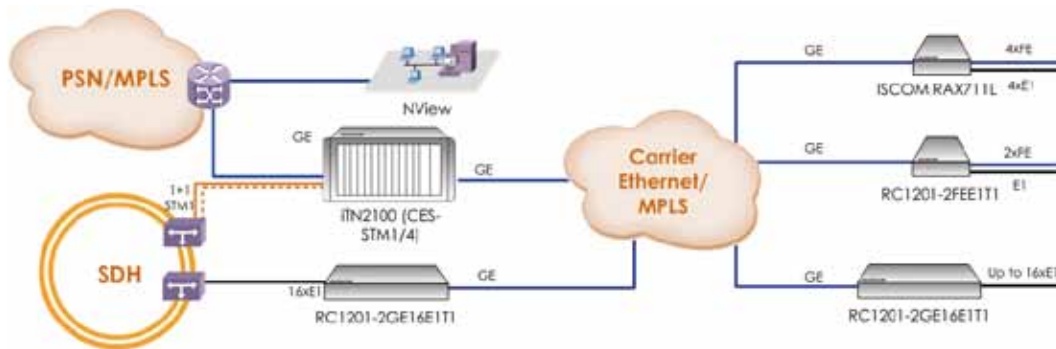

B2B Access with SME Routers

- Carrier-grade SME Router with integrated Ethernet, VoIP and Wifi, for SME/SOHO
- Enables "Triple play" services, hence achieve increased revenues and lowered churn
- Support standard TR-69 protocol for remote access and management
- Multiple types of access technologies (Ethernet, xPON, SHDSL and 3G/4G)

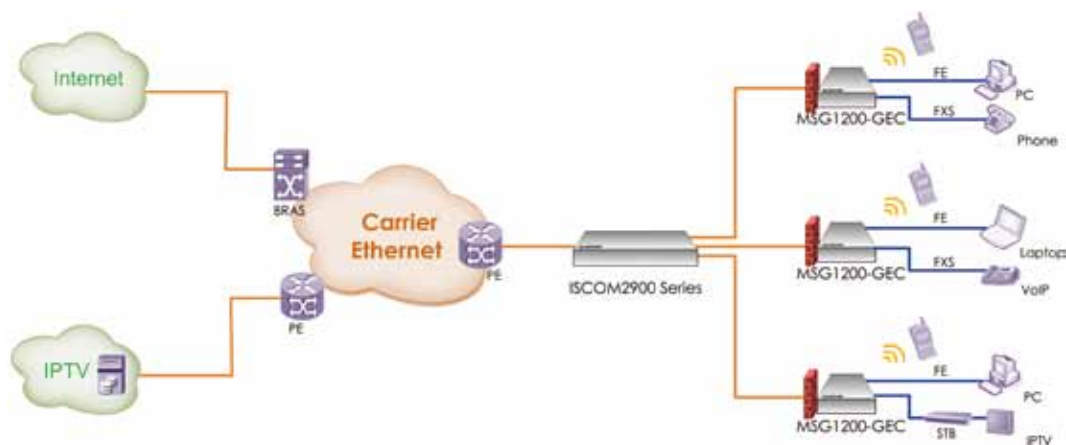

B2B SME Router with 4G (LTE) Backup

- Expanding customer reach and increase customer base by using high-speed 4G LTE network
- SME Router with both wireline and 4G Uplink, with backup ensuring resiliency of customer connectivity data
- Ideal SME router for existing packet transport network
- Support of multiple VRF's enable separation between the providers' management and customers' data traffic

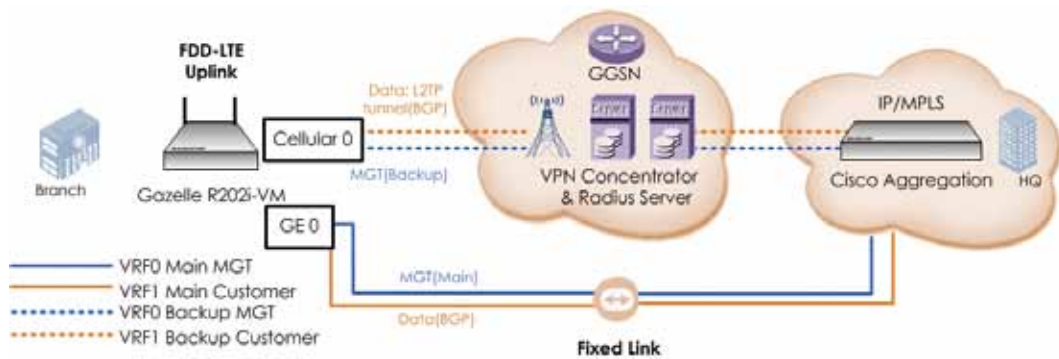

Multi Service Solution for Efficient Fiber Aggregation

- Operators strive to efficiently use their metropolitan fiber networks
- Raisecom's iTN8600 are deployed as access and aggregation nodes
- The iTN8600s build a full service access platform in the metro area
- One network service three networks: Leased line, fixed line backhaul and wireless backhaul
- The solution offer seamless connection with Core and Aggregation layers by PTN/OTN/SDH
- Unified management platform with Raisecom's iTN remote devices
- Manage, enable and deploy service automatically from the iTN8600 NMS

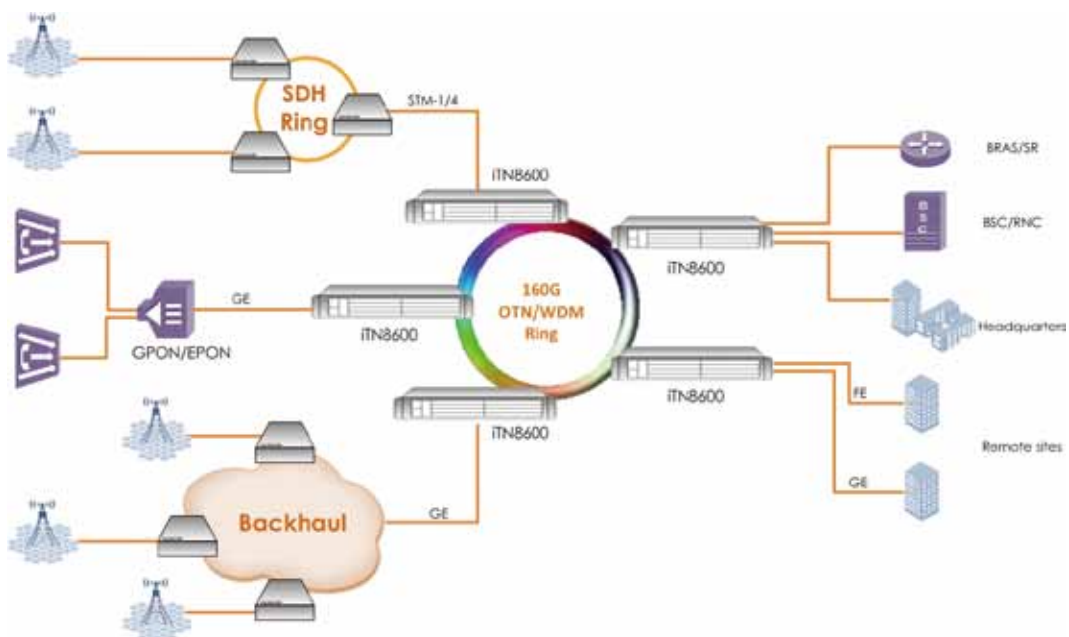



Mobile

The constantly growing number of bandwidth-savvy smartphones and mobile devices drives mobile operators to improve their networks. This includes improved efficiency, increased bandwidth capacity and expanded coverage. The choice of mobile backhaul and fronthaul technologies is becoming a crucial factor for operators aiming to deliver guaranteed mobile services and remain profitable in an era of declining ARPU.

Raisecom mobile backhaul solutions support voice-sensitive and data-intensive traffic at affordable costs. They enable reliable and smooth migrations of multi-G (2G, 3G and 4G/LTE) mobile services over legacy, and packet-based or Metro Ethernet networks. These carefully engineered solutions include some of the following capabilities: auto-provisioning, bandwidth optimization and performance monitoring, which assist in reducing OpEX and increasing network availability. Raisecom's mobile backhauling solutions support various technologies like Carrier Ethernet and IP/MPLS, hence enabling network-wide packetization of operators transport networks.

Raisecom BBU fronthaul solution is used to deliver BBU functionality by Passive Optical Network, xWDM technology or OTN. It helps carriers to dramatically reduce cost and enlarge wireless coverage. Raisecom diversified solution can meet different scenarios for different requirements.

LTE Mobile Backhaul over MPLS

- Mobile operators migrate their transport networks to IP/MPLS for improved resilience and Traffic Engineering
- Raisecom's IP/MPLS-enabled CPEs offer E2E MPLS L3VPN for LTE Service (S1/X2 data)
- NG Multi-G Cell site Router (with MPLS) and MPLS service Aggregator
- Comprehensive timing Synchronization : SYNC-E, 1588 Frequency and phase (BC/TC)
- Multi layer protection and OAM/SLA for the critical Voice data.
- Enhanced QoS ensures low jitter, low latency, stringent traffic engineering and real-time SLA.

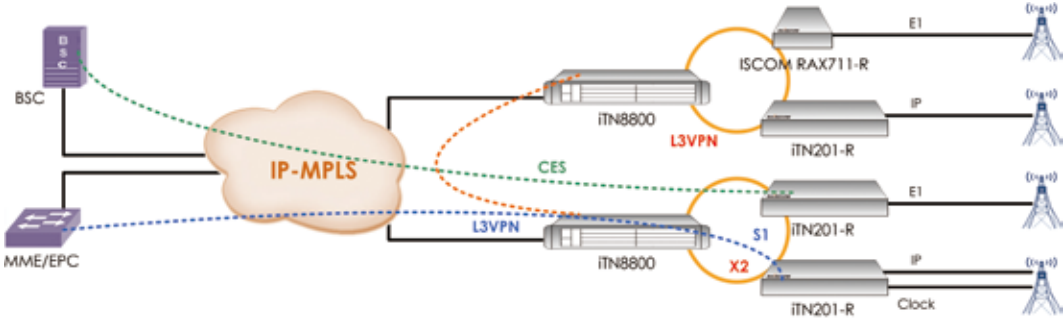

LTE Small Cell Aggregation

- Providing Small cell aggregation based on Ethernet Ring or Daisy Chain
- Built-in 1588 Transparency for accurate 1588 deployment and SYNC-E
- Zero Touch Configuration
- Fitting into necessary harsh space constrains
- Dual Hot Swappable Power Supply units
- Support E1 interface for legacy 2G collocation

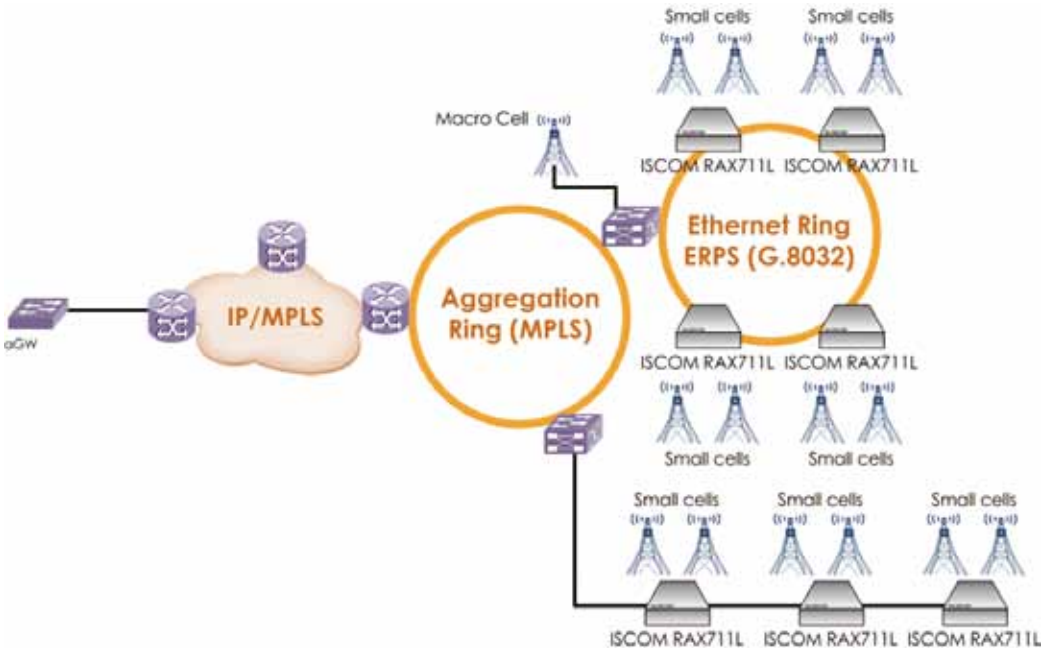

Mobile BBU Fronthaul

- Raisecom's BBU Fronthaul solution aid carrier to extend and enlarge radio coverage for mobile networks.
- The solution lowers operational cost for carriers including rental expense, power consumption, air conditioner and site survey
- Aggregation up to 35 CPRIs (fully protect) per fronthaul system.
- Mobile operators can benefit from the solutions by being able to better maintain and manage complete wireless network.

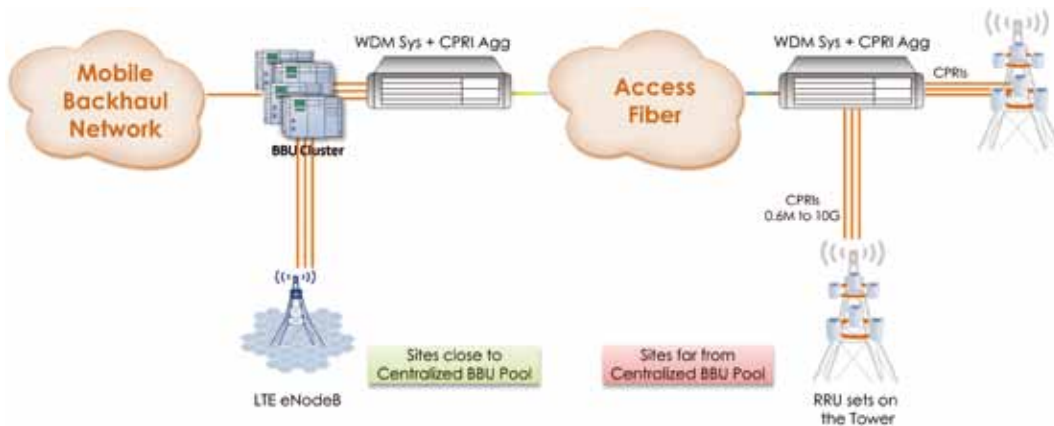

Clock Distribution for MBH with 1588-GM

Distribution of IEEE-1588 "islands" is the best approach allowing:

- GPS savings for every cell-site
- No need for supporting long BC/TC chains across the whole network
- iTN201-1G/10G Mobile Hub site aggregation device with built in GPS receiver and 1588 GM, supporting up to 64 1588 simultaneously sessions (can provide 1588 based Clock to up to 64 remote sites).
- Small Cell site Aggregation (up to 12 GE ports) & Distributed Grand Master device

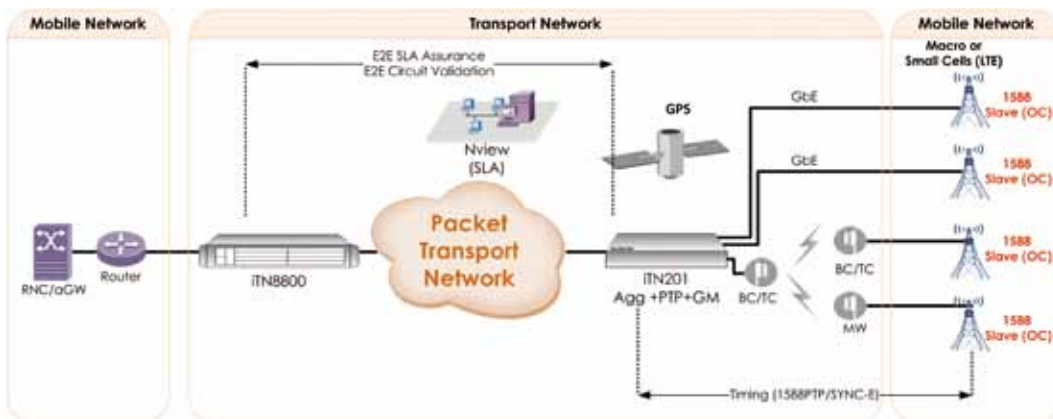

2G/3G/4G LTE Mobile Backhaul over PTN

- Mobile operators have multiple types of cellular networks
- Well-planned transport and backhauling of Multi-G traffic requires packetization
- Enables reliable and smooth migrations of multi-G (2G, 3G and LTE) mobile services over legacy, and packet-based or Metro Ethernet networks
- Raisecom's multi-technology CPEs empower rapid deployments of Multi-G cellular networks
- Support voice-sensitive and data-intensive traffic at affordable costs

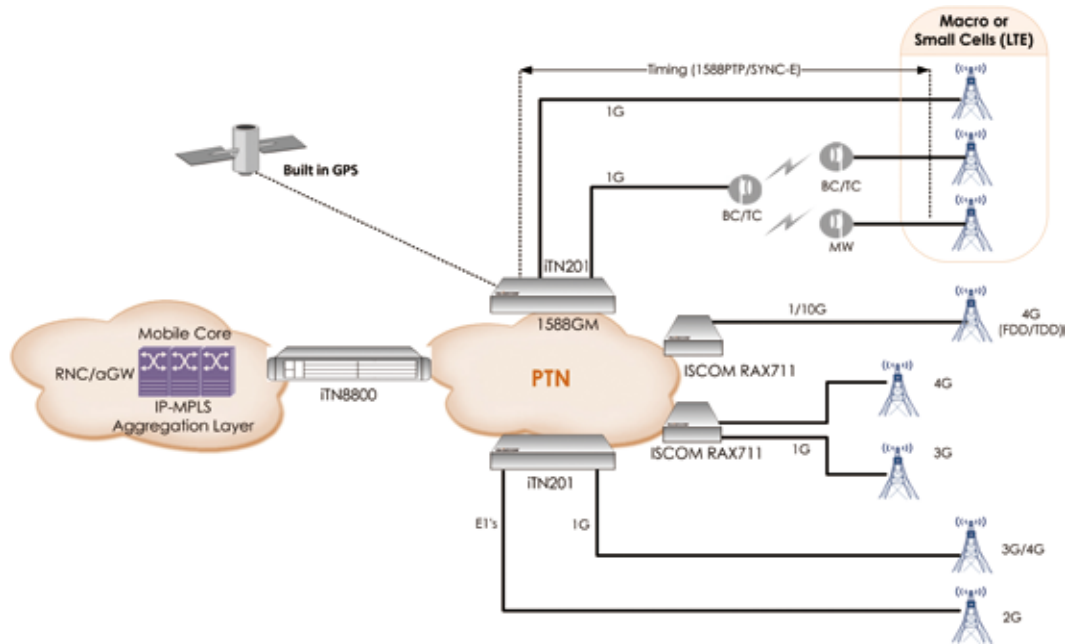



Broadband Access

More and more residential users are benefiting from Fiber To The Home (FTTH) technologies. In addition to the ultra-fast internet access, these users can also benefit from triple services (Internet + Voice + Video) using the same infrastructure at reasonable costs. Some broadband service providers are now adding a fourth service (Mobile/FMC) and this increases the bandwidth usage and the need for QoS.

Raisecom offers both active Carrier Ethernet (AON-Active Optical Networks) and passive optical network (PON-Passive Optical Networks) access and aggregation solutions for high-density urban residential applications. Comprehensive streams of voice, data, video and sometimes cellular can be delivered to rural and less populated areas with low cost fiber, copper and wireless routers.

The versatile solutions enable fast deployments and pay-as-you-grow approach.

10G/40G L2/L3 Metro Access Rings for Business Services

- Broadband providers like city carriers and national wide Tier3 providers offering 1G services are seeking for faster backbone links
- Raisecom's carrier-grade Ethernet switches enable fast deployment of All-Ethernet networks for multi-play services
- With such capabilities like powerful 1.2Tb switching, resilience (on 40G and 10G ports) features and hardware redundancy, the switches enable highly-scalable networks.
- In addition for broadband Ethernet, the solutions can also be sued for EaaS and Metro-Ethernet services



Ethernet-based Residential FTTx

- Service providers are seeking cost-effective networking solutions for triple play services
- Active Ethernet is ideal for "Triple play" Services (Internet, Voice, Video)
- In FTTB networking, target market is residential buildings. Services offered include: High speed internet, IPTV service and voice (VoB).
- In FTTH networking, target market is residential and business areas. Services offered include: High speed internet, IPTV service and voice (VoB).
- Service providers only offer Ethernet connectivity (FE or GE) as the basic service and can add additional services via Routers and STBs.
- Rasiecom's Ethernet switches offer perfect match for the FTTx application due to their video distribution and QoS features

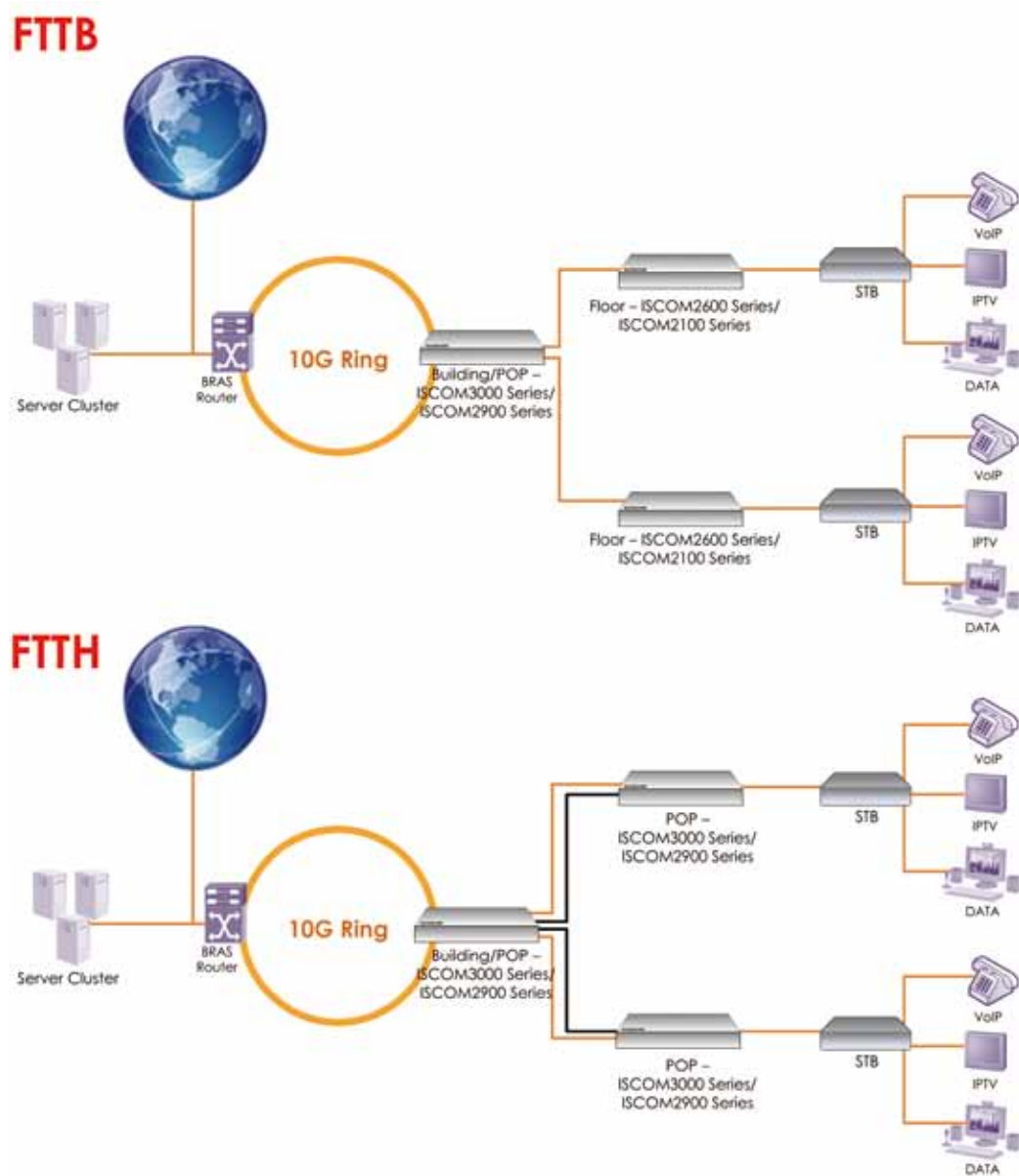

Building a Broadband Access GPON Network for Tier 2/3 Service Providers and ISPs

- Raisecom's GPON OLTs proved to be the most cost-effective option for ISP's and Tier 2/3 deployments
Optimized solution for a scale between 500 to 20,000 customers
- With a pay-as-you-grow approach, scalable OLT that will enable fast deployment and future growth (by populating additional service slots)
- Raisecom's ONT offerings allow service providers to offer different service bundles to different users
- Carrier Class Network management solution, reduce Capex with "Zero Touch" provisioning towards the ONT and TR69 option enables auto configuration of ONT from ACS Server

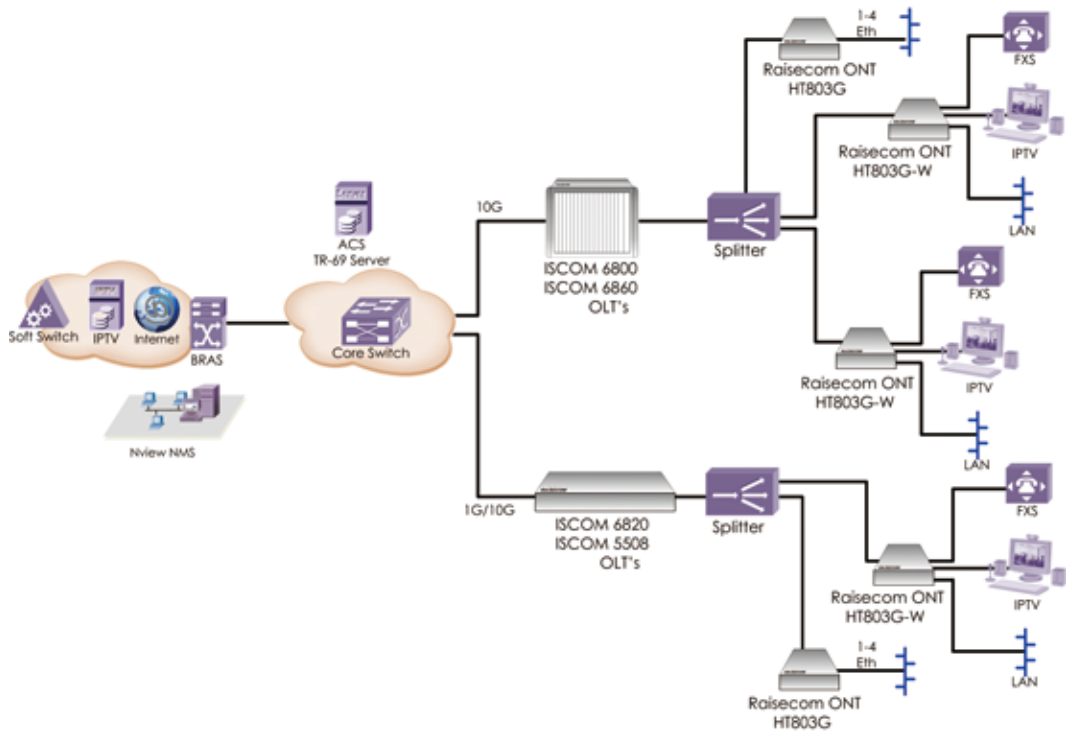

GPON Network for Rural/Regional Broadband Access

- Optimized solution for serving 1000-3000 Customers
- A pay-as-you-grow scalable OLT that will enable fast deployment and future growth (by adding additional slots)
- Carrier Class Network management solution, reduce Capex with "Zero Touch" provisioning towards the ONT and TR69 option enables auto configuration of ONT from ACS Server.

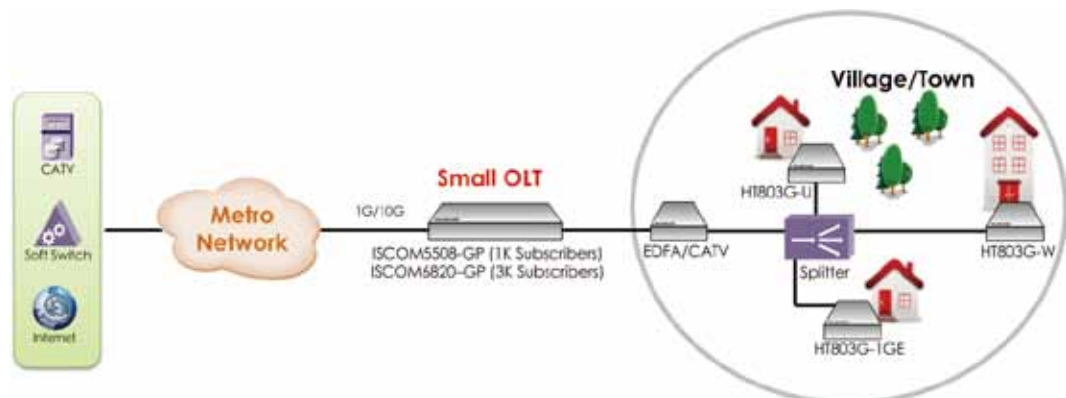



Mission Critical Networks

Industrial and utility applications present unique challenges for network planners. First, they involve mission-critical traffic, which may be closely related to public safety and people's every-day life, and requires high network reliability and resiliency. Typically, it is needed to support various types of traffic like: low-speed data communication, digital and analog voice, TDM circuits and analog control, mobile traffic, multimedia traffic, integrated surveillance and broadband access and more. In addition, equipment must survive a wide range of environmental conditions and comply with the stringent industrial conditions.

Raisecom provides PCM connectivity solutions for SCADA traffic as well as Ethernet-based industrial products. This combination serves the broadband demands in the fields of energy (power, gas, oil, mining, water), transportation, public information and military.

Smart Grid Communication for Power and Utilities Companies

- Ethernet is becoming a valid Packet transport technology for the U&T vertical
- Data aggregation and distribution in the U&T environments dictate specific technical requirements
- Raisecom's Industrial switches were design to meet IEC 61850-3 compliance,
- The switches offer addition capabilities and features :
 - Distribute SCADA RTU (Distribution automation devices), along with IP surveillance (Video Camera)
 - Daisy chain and Ring protection topologies (ITU G.8032)
 - Synchronization: GPS input and all switches complies with 1588v2 (power profile)
- Flexible port type e.g. IRIG-B AC/DC (Take timing from PTP and convert it to IRIG-B)

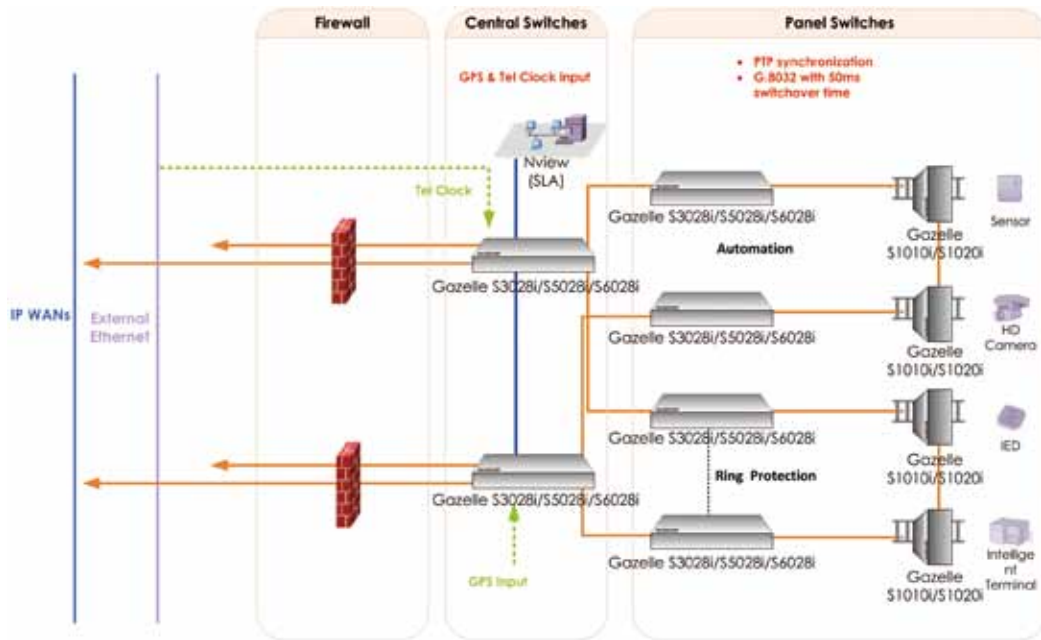

Migration to Packet over MPLS Transport Core

- Packetization of transport networks is occurring in various market verticals
- In order to assure seamless migration, Utilities and Power companies have stringent requirements
- Raisecom's MPLS-enabled CPE and Aggregation solutions can be used for these applications
- The solutions enable End to End substation connectivity with MPLS-TP or IP/MPLS
- In addition, the solutions present additional capabilities:
 - Extend routing and MPLS capabilities to remote sites, hubs and network edges
 - Traffic engineering (TE) achieved via advanced QoS in L2VPN and RVSP-TE in L3VPN
 - Realize network resiliency via G.8031/8032 and LAG in L2VPN as well as G.8131, FRR, VRRP, CSPF, etc. in L3VPN.
 - Pseudowire supporting STM-1 up to STM-1.6 for smooth network migration from SDH
 - Fully End to End manageable services

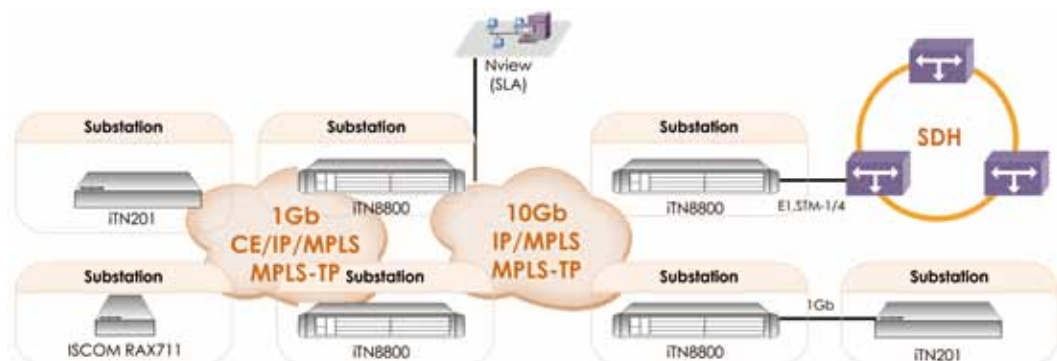

Machine-to-Machine (M2M/IoT) Solution for Smart Metering and Automation

- Cellular networks enable an ideal connectivity to remote locations
- U&T verticals have to connect large number of remote locations for telemetry and other applications
- Raisecom's range of industrial routers can be widely used in M2M and IoT applications.
- Smart Grid Router, located at the secondary substation (LV transformers) for backhauling Distributed automation devices (RTU, Power monitoring) and Meter concentrators over Cellular networks
- The routers, which can be used over multi-G cellular networks, offer a number of features like :
 - Static and Dynamic Routing
 - L2TP VPN with IP Sec or GRE tunnels
 - Serial interfaces

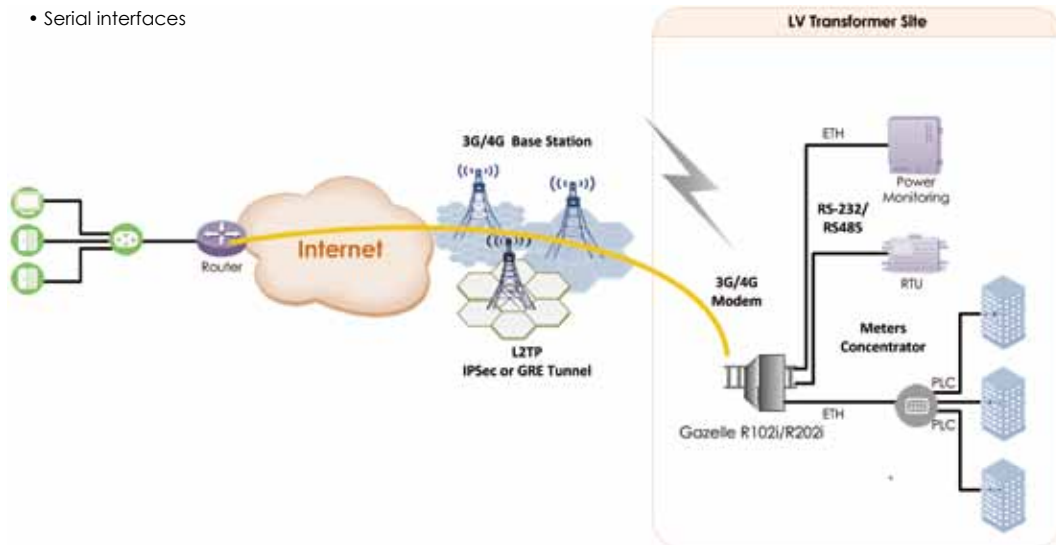

Highway Security, Monitor & Automation

- Raisecom's Industrial Switches combine carrier-grade networking capabilities with industry-specific specifications
- The industrial networking solutions enable the creation of L2 Access Rings and L3 core Rings for Highway security and Monitoring information
- The various model can be used in numerous scenarios in highways and railways verticals

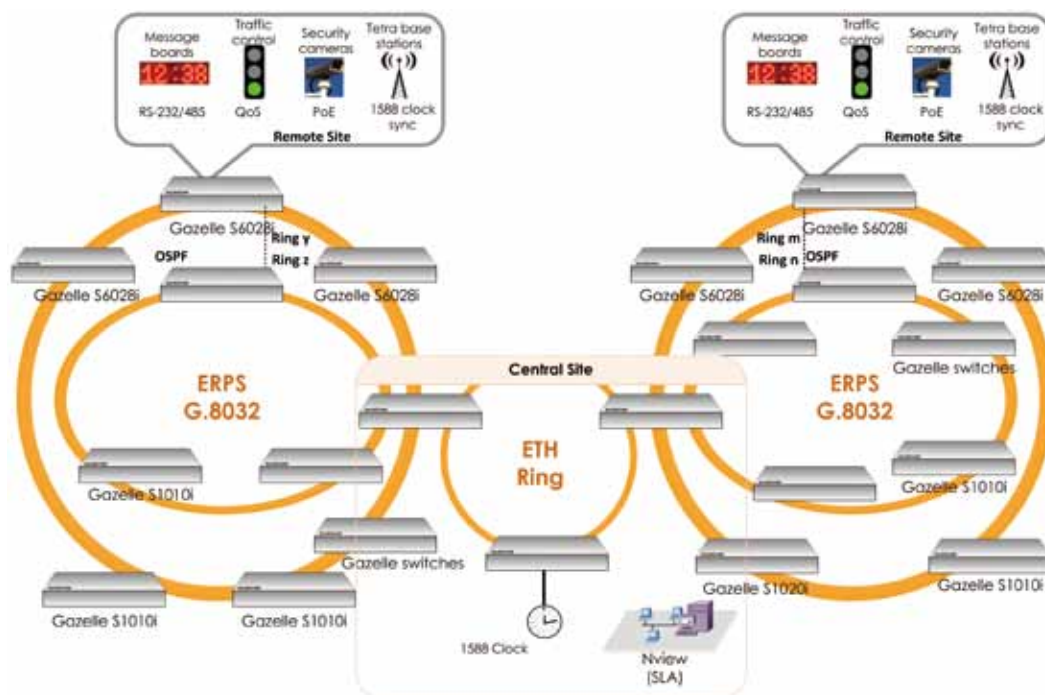

Substation Multiservice with Readiness for MPLS-TP/IP-MPLS Core Migration

- Power companies have very specific needs with regard to the multi-service handling and communications : SCADA, Analog Voice, TP, Ethernet etc..
- Raisecom's PTN offerings enable maintaining the legacy equipment while offering a clear path towards an all-packet network.
- The wide range of low speed, PDH, SDH and Ethernet interfaces as well as the ability to use MPLS, makes Raisecom's offering ideal for the migration needs of power companies

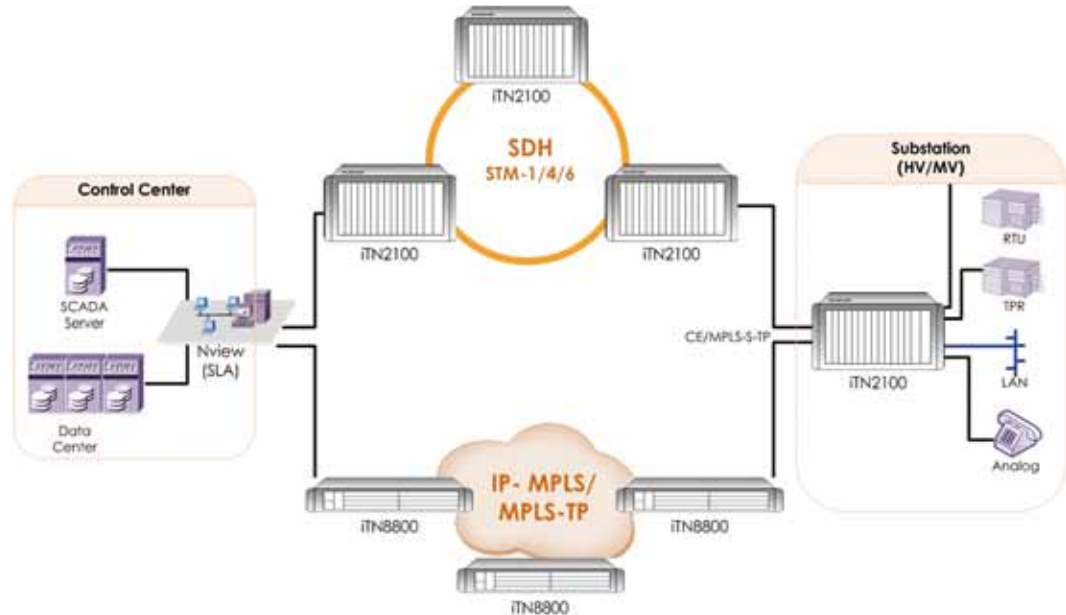

“Hybrid” Multiservice a Connectivity and Migration Platform for Mission Critical Networks

- Compact 1.5U (iTN221), Powerful cross- generation multiservice platform for Legacy TDM and new Ethernet/IP Service
- TDM DSO cross connect, SDH Ring (STM-1/4), Gigabit Ethernet switching and built in CESoIP capabilities
- PTN based on MPLS-TP or CE (MEF 2.0)
- Guarantee Smooth Migration towards new PTN Network

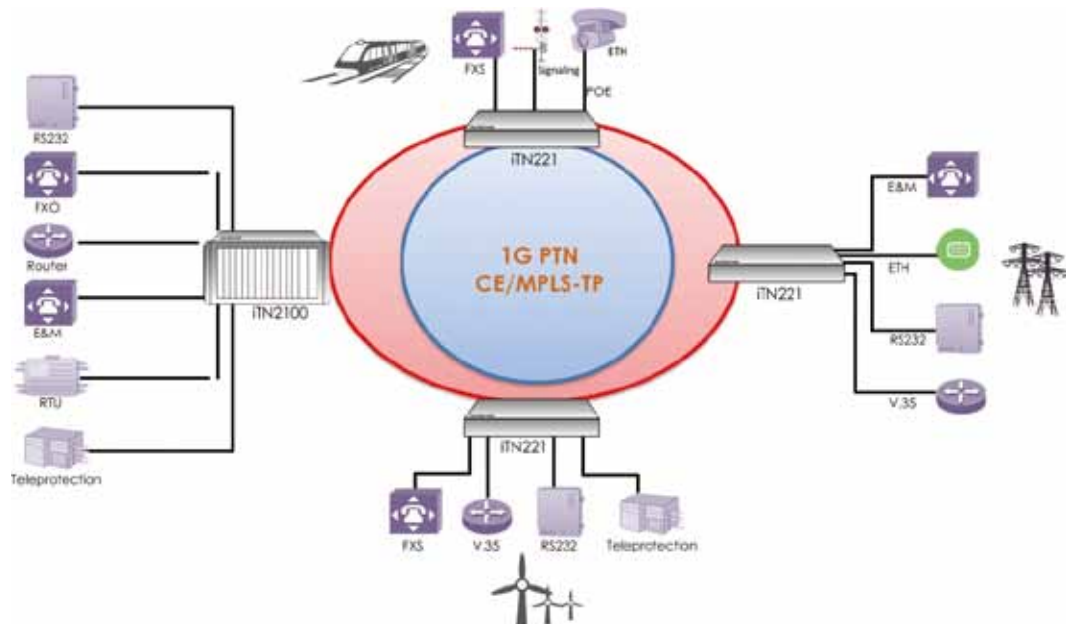

Mobility Systems for Vehicles and Trains

- The 3G/4G LTE access router enable high speed vehicles to overcome mobility and vibration issues for communication
- Din Rail mounting design with AC and DC power supply
- Electro magnetic compatibility and voltage jump proof
- Extended temperature range: -40 °C to 85 °C. comply with EN50121 (Standard for railway)
- Achieve carrier uplink as active, 4G uplink backup.

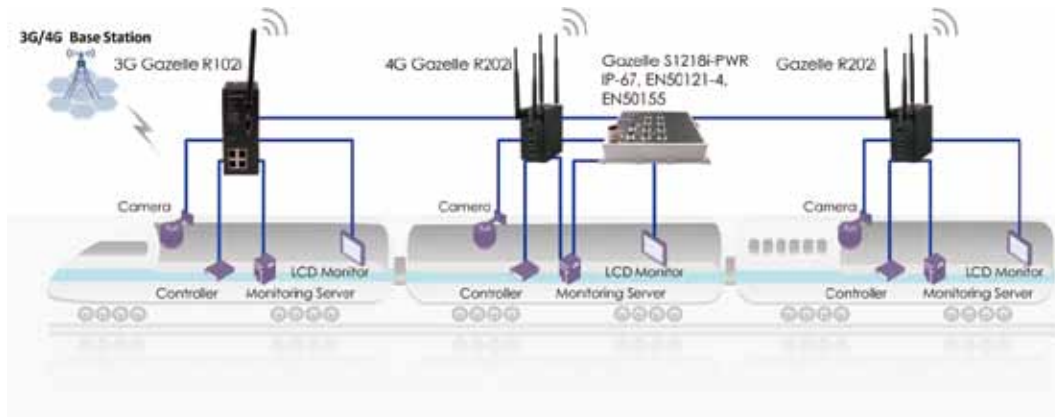

Substation Multiservice for Utility

- Provide reliable transmission of critical control signals and data traffic between central offices and substations.
- Delivery of SCADA, Teleprotection, voice, LAN, data and video streams using reliable and robust multi-service solutions
- Maintaining the Legacy equipment and installed based.
- Dual Core architecture solution supporting both SDH (TDM) and PTN (CE and MPLS-TP), smooth migration towards PTN networks

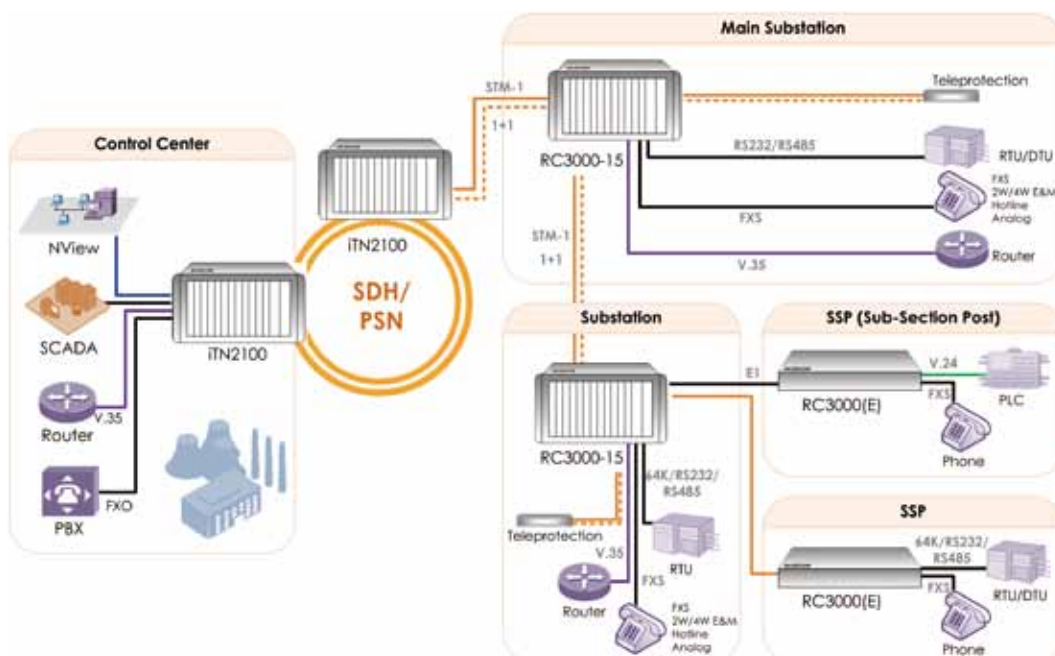



Enterprise and Government

Small and medium size businesses create a vast marketplace for telecommunication players, by migrating their business solutions to the Internet and cloud. The required information-base is a crucial factor for SME owners to stay in the market, and requires secured, powerful and cost-effective networking.

Raisecom provides extremely cost-effective VPN access solutions for SME users that help to overcome such challenges as the lack of IT capabilities, limited budget, and the need for secured access. Raisecom solutions offer features like device integration, service integration and customer benefit maximization. These solutions assist SMEs to fully utilize private and public cloud network by combining routing, Ethernet switching, voice-support, 3G/4G backup, Wi-Fi, VPN and secure-access features in their devices.

Safe City/Smart City Monitoring and Public wifi Access

- End to End backhauling solution for Video Surveillance (IP Camera) to ensure city security
- Industrial Ethernet switches with built in PoE (Power to the IP camera)
- Resiliency on the backbone site, GbE G.8032 Ring over Fiber
- Full suite of Layer 2 Ethernet features and function
- Suitable for outdoor installation, street cabinets with DIN Rail mounting

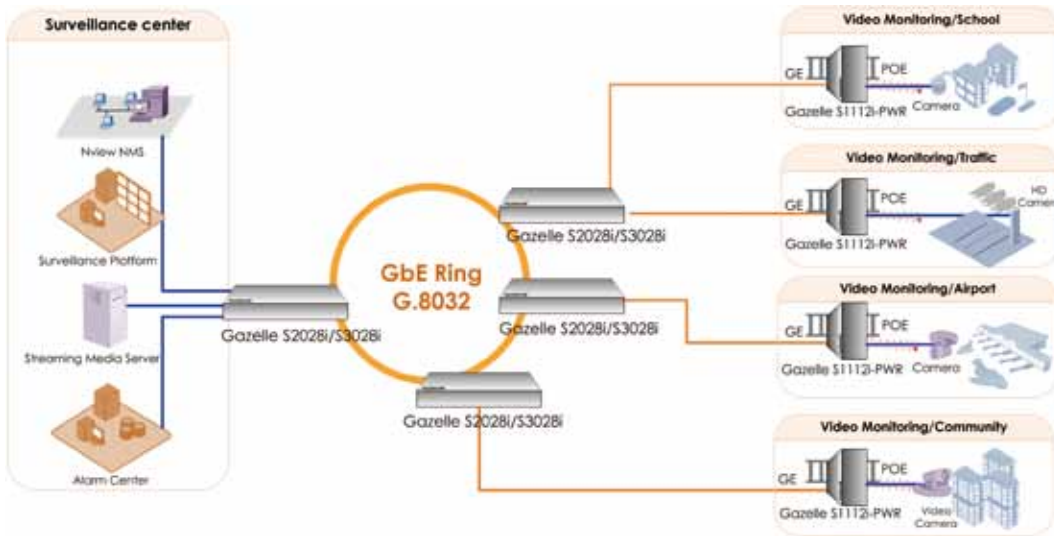

Data Center High-speed Connectivity for Servers and Storage over 40Gbps Rings

- High Capacity Switching 1.28T
- Supporting up to 48x 10G interface and 4x40G (QSFP) on the network site in 1U form factor
- Multiple network redundancy mechanism: G.8032, Link Aggregation (802.1ad) ensuring <50msec switch over time
- Stacking option enhancing reliability by 1:N HW redundancy and enhancing the bandwidth with extended port number

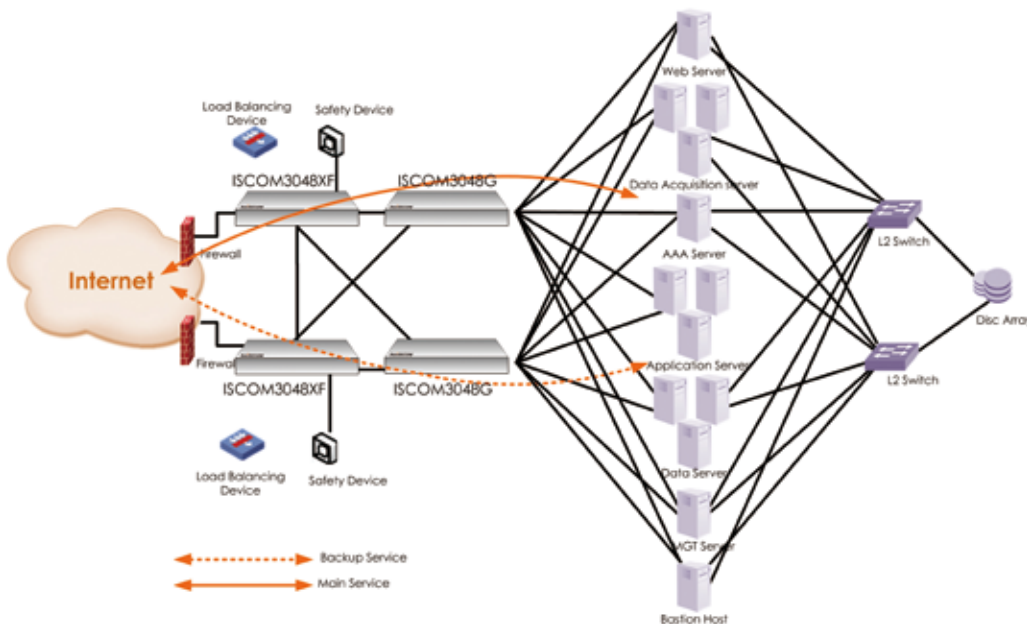

Data Center Interconnect (DCI) Solution with WDM/OTN

- Support 1/2/4/8/10G Fiber channel and 1GE/10GE Ethernet interface
- Space Saving high-density platform, the iTN-8600-II is only 2U/35 10G ports and the iTN8600-V is only 5U/75 10G ports
- Low latency, supports real-time applications, Low transmission delay (<1 us)
- Supports long distance up to 100 km
- Low power consumption port 3.8W with SFP
- Management platform is mature and easy to use

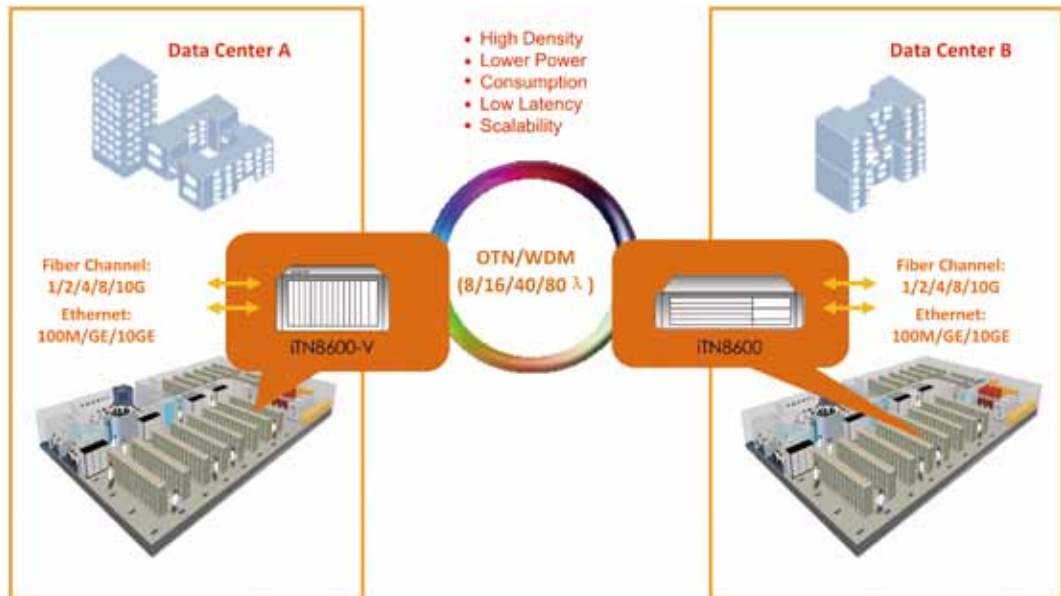

Smart City & IoT

- Ruggedize Router with Ethernet /Serial interfaces with Cellular uplink backhauling the IoT traffic
- VPN over Cellular, supporting commercial grade security (IPsec, L2TP, GRE)
- Industrial Grade quality, IP-40 with extended temperature -40c to 70c
- 2G/3G and 4G support with various bands
- Dual SIM card

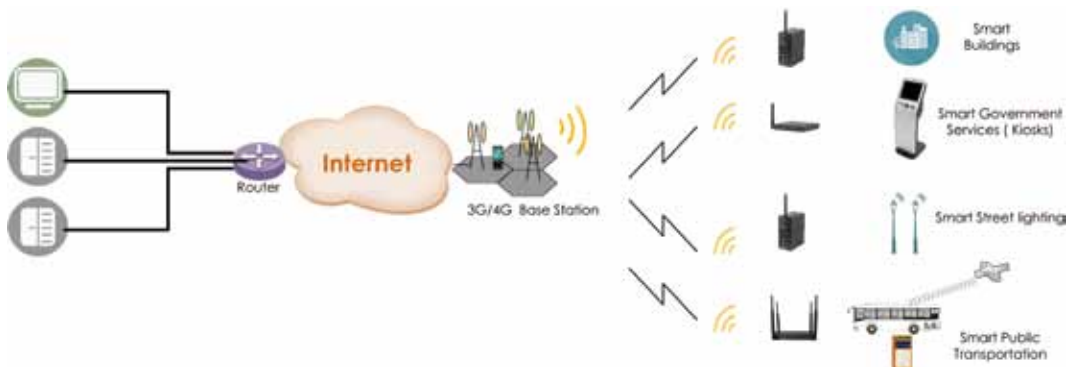

L2&L3 Switches Solution for Government & Enterprise Branch Office Connectivity

- L2 and/or L3 Switches are used for interoffice service connectivity and connection to the Enterprise WAN Network
- Raisecom's Switches offerings advanced L2 features with QoS, followed with enhanced security features
- Support rich protection features on Port/Network level (i.e 1+1, LAG, Rings: STP/RSTP/MSTP, G.8032) ensuring Network Resiliency and minimal down time
- Variety of speeds: FE/GE/10G/40G and PoE

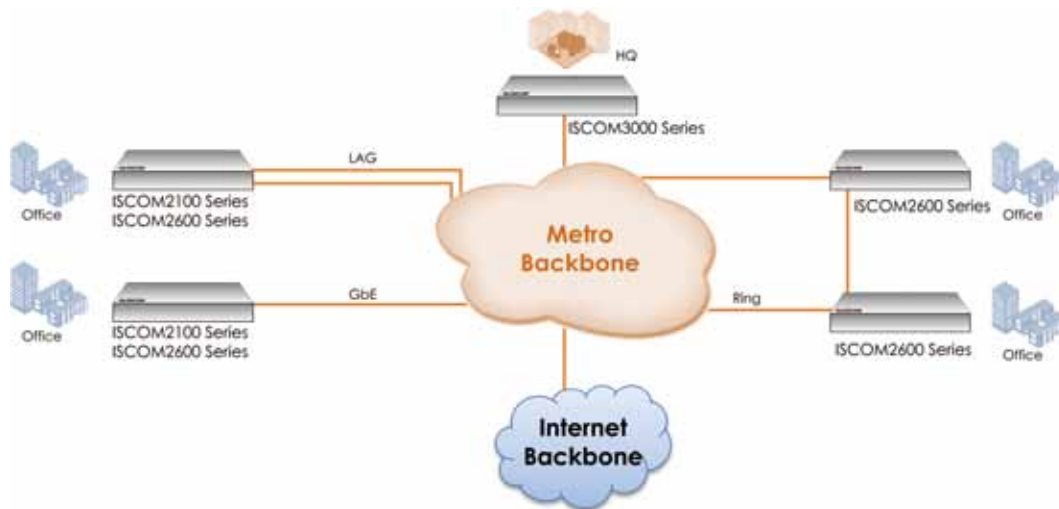



PRODUCT CATALOG



Chapter 1. Carrier Ethernet

Raisecom offers a complete line of Carrier Ethernet (CE) switches, aggregation and demarcation devices. The MEF-certified Carrier Ethernet 2.0 product line can be used to deliver E-Line, E-LAN, E-Tree, and E-Access services. These services can provide end-to-end SLA and QoS monitoring and full service performance visibility as well as OAM, CFM, multi-CoS and other carrier-grade Ethernet protocols. Typically used to provide SLAs and service assurance for business services, CE2.0 products are vital for demarcation between service providers.

Ethernet Demarcation Device

ISCOM RAX701, ISCOM RAX711L, ISCOM RAX711(B)

These next generation Ethernet demarcation devices can be used for E-Line, E-LAN, E-Tree, and E-Access services for large enterprises and small/medium business services, as well as mobile backhaul. They comply with ITU-T Y.1564 SAT for the service turn-up, and they guarantee end-to-end SLA performance monitoring and service visibility based on hardware that is capable of supporting OAM, CFM and Y.1731 SLA. The service-based QoS helps to differentiate flows and to commit forwarding priority within each EVC. In addition, the EDDs support ITU-T G.8032/1, providing ring protection with a sub-50ms recovery for MBH and business connections.

Due to today's network challenges related to deploying, provisioning, managing and trouble-shooting Ethernet devices, Raisecom introduces the CEView auto-provisioning GUI tool, which provides an integrated, effective and economic solution for Carriers to gain additional benefits from Metro Ethernet. CEView can be supported by ISCOM RAX711L and RAX701.



ISCOM RAX701



ISCOM RAX711L



ISCOM RAX711(B)

FEATURE

- ITU-T G.8031/8032 ELPS/ERPS with sub-50ms switch-over time
- ITU-T Y.1564 SAT and RFC2544
- Hardware-based IEEE802.3ah OAM, 802.1ag CFM, Y.1731/SLA,
- TWAMP light (Generator & Reflector)
- "Zero-touch" provisioning Synchronization: SYNC-E and 1588-TC
- NView, CEView, Web-portal based SLA report
- CE2.0 Certified E-Line, E-LAN, E-TREE and E-Access services

P/N	ISCOM RAX701	ISCOM RAX 711L	ISCOM RAX 711(B)
NNI Interface	2 x FE/GE SFP	2 x GE SFP	2 x GE SFP
UNI Interface	1 x FE/GE combo	4 x GE combo	4 x GE combo
E1 PWE	N/A	4 x E1	N/A
Clocking	1588-TC	SYNC-E, 1588-TC	N/A
Dimension	180 (W) × 160 (D) × 43.6(H) mm3	220 (W) × 180 (D) × 43.6(H) mm3	220 (W) × 180 (D) × 43.6(H) mm3
Power	100-240V AC, -36 to -72V DC WP Full Load: ≤ 12W	100/240V AC, -36 to -72V DC Full Load: ≤ 15W	100/240V AC, -36 to -72V DC Full Load: ≤ 25W
MTU	12,288 Bytes	12,288 Bytes	12,288 Bytes

SDN-Enabled Ethernet Demarcation Device

ISCOM RAX711-G

Raisecom has designed SDN-enabled Ethernet Demarcation Device (SPTN – Software-defined Packet Transport Network), a new PTN EDD that SDN capabilities to the EDD and combines centralized intelligent control of SDN with efficient multi-service transmission capabilities, carrier-grade reliability and end-end QoS guarantee.

The SDN EDD can be used to provide Carrier Ethernet and MPLS-TP services for mobile backhauling(MBH), large enterprises, and small/medium business services. The Software Defined Networking enables organizations to accelerate application deployment and delivery of service, while reducing IT cost through policy-enabled workflow automation. SDN accomplishes these business objectives by converging the management of network and application services into centralized extensible orchestration platform that can automate provisioning and configuration of network infrastructure including Raisecom's new SDN enabled EDD. Raisecom's RAX-711G supports SDN Openflow and Netconf interface protocols.



ISCOM RAX711-G

It is also able to offer EDD features such as ITU-T Y.1564 SAT for the service turn-up and end-to-end SLA performance monitoring and service visibility based on hardware that is fully compliant with OAM, CFM and Y.1731/SLA. The Service-based QoS helps to differentiate flows and to commit forwarding priority within each EVC, and it supports ITU-T G.8032/1, providing a ring/linear protection within a sub-50ms for MBH and business connections. In addition, the RAX711-G supports provisioning of MPLS-TP VPWS, OAM and MPLS-TP protection.

FEATURE

- ITU-T G.8031/8032 ELPS/ERPS with sub-50ms switch-over time
- ITU-T Y.1564 SAT
- Hardware-based IEEE802.3ah OAM, 802.1ag CFM, Y.1731/SLA, TWAMP light (Generator & Reflector)
- Synchronization: 1588v2 and SyncE
- Automatic service provisioning configuration and modification
- SDN southbound Openflow and Netconf
- CE2.0 Certified E-Line, E-LAN, E-TREE and E-Access services

P/N	ISCOM RAX 711-G
NNI Interface	2 x GE SFP
UNI Interface	4 x GE combo
Dimension	220 (W) × 180 (D) × 43.6(H) mm3
SDN	Openflow and Netconf
Clock	SyncE/1588v2
Power	100/240V AC, -36 to -72V DC Full Load: ≤25W
MTU	12,288 Bytes

Carrier Ethernet Switch

ISCOM2900 Series

The Carrier Ethernet aggregation switches feature high capacity, assured SLA, full redundancy protection, consistent performance and integrated management. These switches complement the Raisecom Carrier Ethernet Demarcation devices. The manageable L2 aggregation switch features a powerful hardware design supporting up to 4 x 10G Ethernet uplinks and offering optional redundant hot-swappable AC or DC power supplies. The ISCOM2900 series are often used for scalable aggregation in metropolitan area networks, business services, mobile backhaul and cloud access. Additionally, with up to 48 SFP or electrical interfaces, ISCOM2900 series enable flexible service offerings and provides access rates up to 1000Mbit/s. This ensures high transmission quality and efficiency. In addition, this series plays an important role in accelerating large-scale deployment and provides diversified access solutions due to its high bandwidth provision (10G) and H-CAR (Hierarchical QoS) performance. The entire series complies with MEF CE2.0 services such as E-Line, E-LAN, E-Tree and E-Access. It also supports standards such as E-LMI, IEEE802.1ag/802.3ah, ITU-T Y.1731/G.8031/G.8032 and LLDP. The L2 MPLS VPN is also available via software upgrade.



ISCOM2924GF-4C



ISCOM2924G-4C



ISCOM2948GF-4C



ISCOM2948G-4C

FEATURE

- Dual software images
- ITU-T G.8031/8032 ELPS/ERPS with sub-50ms switchover time
- VLAN QinQ ACL per port/VLAN/EVC/CoS
- Hardware-based IEEE802.3ah, 802.1ag, ITU-T Y.1731 and L2/L3 SLA
- IGMP MVR, DHCP, IPv6 and TACACS+
- Hot-swappable redundant power supply and fan modules
- Automatic service provisioning configuration and correction
- CLI, Telnet and SNMP (NView Compatible)
- CE2.0 Certified E-Line, E-LAN, E-TREE and E-Access services

P/N	ISCOM2924GF-4GE	ISCOM2924GF-4C / ISCOM2948GF-4C	ISCOM2924G-4C / ISCOM2948G-4C
NNI Interface	4 x combo GE interfaces	4 x 10GE SFP+ interfaces	
UNI Interface	24 x 10/100/1000M Base-T RJ45 ports 24 x 1000M Base-X SFP interfaces	24/48 x 100/1000M Base-X SFP interfaces	24/48 x 10/100/1000M Base-T RJ45 ports
Dimension	440(L) x 360(W) x 44(H) mm3		
Power	Hot-swappable redundant power supplies		
MTU	12,288 Bytes		

L2 Manageable Full Gigabit Access Switch

ISCOM2600 series

The ISCOM2600G is a Layer 2 Gigabit Ethernet switch that offers carrier-grade performance. The ISCOM2600G series includes several model options such as the ISCOM2608G-2GE (8GE + 2 Combo SFP/electrical interfaces), ISCOM2624G-4GE (24GE + 4 GE Combo SFP/electrical interfaces), ISCOM2648G-4C (48GE + 4 x 10G SFP+ interfaces), and ISCOM2648G-4GF (48GE + 4 x GE SFP interfaces). The wide variety of interfaces makes the ISCOM2600G a good fit in many applications in the service provider's network. The ISCOM2600G, with advanced switching structure, also supports static route and seamless connection with Layer 3 routing devices. With flexible networking modes, high reliability, easy maintenance, individualized QoS, various security guarantees, and advanced system management, the ISCOM2600G can fully meet the requirements of all network carriers. The series is highly applicable for networking needs for enterprises, campuses, residences, and CDN.



ISCOM2600 series

FEATURE

- High capacity, high density
- High reliability and protection
- STP, RSTP, MSTP, and multi-RSTP
- LACP and MLACP
- ITU-T G.8032 with fault switching time less than 50ms
- Dual-system and dual-configuration-file redundancy backup
- IEEE 802.1x ACL based on interface and MAC modes and support various AAA mode such as RADIUS, TACACS+
- Port secure MAC and limits on the MAC addresses to stop attacks from illegal users
- Various ACL policies to control packet forwarding flexibly
- DHCPv4/v6 Snooping and Option 82/18/37 to avoid DHCP attacks
- DAI and IP Source Guard based on the DHCP binding table to prevent ARP flooding attacks and IP attacks
- Broadcast storm and loop detection to ensure the stability of the network
- Lightning protection for the power supply and all the Ethernet electric interfaces and protect hardware investment of the customer
- Fine tunable QoS with rich scheduling policy such as SP, WRR, or SP + WRR, DRR, or SP+DRR
- Dual-bucket three-color CAR based on the traffic and H-CAR
- Statistics based on traffic
- IPv6 Ready

- IPv6 ACL, DHCPv6 Snooping, RA Snooping and Option18/37 to ensure the network security
- MLD Snooping to ensure the IPv6 multicast monitoring
- Full suite OAM & SLA
- Point-to-point IEEE802.3ah link monitoring
- Advanced management system
- SNMP, RMON, Telnet, SSH and provide friendly WEB management interface to increase the usability of the device
- Automatic configuration and loading. The administrator can put the configuration file set in advance to the TFTP server for the automatic loading of the switch while it is booting, thus simplifying the management and maintenance

Device	ISCOM2608G-2GE	ISCOM2624G-4GE	ISCOM2624G-4C	ISCOM2648G-4GF	ISCOM2648G-4C
Port type	Uplink: 2 x GE Combo Downlink: 8 x GE RJ45	Uplink: 4 x GE Combo Downlink: 24 x GE RJ45	Uplink: 4 x 10G SFP+ Downlink: 24 x GE RJ45	Uplink: 4 x GE SFP Downlink: 48 x GE RJ45	Uplink: 4 x 10G SFP+ Downlink: 48 x GE RJ45
Management interface	1 SNMP interface, 1 Console interface, 1 out-of-band interface				
Switching capacity	20Gbit/s	56Gbit/s	128Gbit/s	104Gbit/s	176Gbit/s
Packets switch rate	14.88Mpps	41.66Mpps	95.23Mpps	77.38Mpps	130.94Mpps
Dimensions	320(L) × 200(W) × 43.6(H) mm3	440(L) × 220(W) × 43.6(H) mm3		440(L) × 300(W) × 43.6(H) mm3	
Weight	2.2kg	< 2.6kg		< 4.3kg	
Power consumption	< 20W	< 25W		< 45W	
Voltage range	100–240 VAC, -32 to -72 VDC				
Hardware	<ul style="list-style-type: none"> • Single power, fan-free (except the device with 48 interfaces) • Working temperature: 0–50°C • Relevant humidity: 10%–90% RH (non-condensing) • Lightning protection level (service interface/ power interface): 6 kV in common mode 			<ul style="list-style-type: none"> • Single power • Working temperature: 0–50°C • Relevant humidity: 10%–90% RH (non-condensing) • 2 kV in common mode 	

L2 Carrier-Grade FE Access Switch

ISCOM2110EA-MA, ISCOM2128EA-MA

The ISCOM2100EA-MA L2 access switch provides solutions for both triple-play FTTH and EPL/EVPL. It offers key access features such as port-based/selective QinQ, VLAN mapping, advanced Access Control List (ACL) and bandwidth management policies that facilitate customizable Quality of Service (QoS). It also supports important management and monitoring functions based on the following Carrier Ethernet standards: IEEE802.3ah, IEEE802.1ag and ITU-T Y.1731, which are implemented to guarantee SLA as fundamental modules in both products. In addition, this series includes the ISCOM2100-PWR Carrier Grade PoE switch. The ISCOM2100-PWR provide 8-24 PSE+ Fast Ethernet downlink access interfaces (up to 30 Watts per port) with 2/4 x Gigabit combo uplinks. The ISCOM2100-PWR PoE switches offer a power supply for power demand (PD) devices such as wireless Access Point (AP)



ISCOM2110EA-MA



ISCOM2128EA-MA

FEATURE

- VLAN, QinQ, ACL per port/VLAN/CoS
- IEEE802.3ah, 802.1ag, ITU-T, Y.1731/SLA
- IGMP, MVR, Multicast-filtering, DHCP, IPv6 and TACACS+
- Power supply redundancy via RPS module (ISCOM2128G series ONLY)
- STP and Ethernet Ring (50ms switch-over)
- CLI, Telnet and SNMP (NView compatible)
- CE1.0-certified E-Line and E-LAN services, and CE2.0-compliant E-Line, E-LAN, E-TREE and E-Access services

P/N	ISCOM2110EA-MA	ISCOM2128EA-MA
WAN Interface	2 x 100/1000M Base-X SFP interfaces	4 x combo GE interfaces
LAN Interface	8 x 10/100/1000M Base-T RJ45 ports	24 x 10/100M Base-T RJ45 ports
Ring protection	STP; Raisecom Ethernet Ring	G.8032 ERPS
Power	Single AC/DC	Power supply redundancy

Carrier-Grade L2 Access PoE Switch

ISCOM2608G-2GE-PWR, ISCOM2624G-4GE-PWR ISCOM2110EA-MA-PWR, ISCOM2128EA-MA-PWR

The ISCOM2100EA-MA L2 access switch provides solutions for both triple-play FTTH and EPL/EVPL. The ISCOM2100EA series offers several key access features such as port-based/selective QinQ, VLAN mapping, advanced Access Control List (ACL) and bandwidth management policies that facilitate customizable Quality of Service (QoS). It also supports important management and monitoring functions based on the following standards: IEEE802.3ah, IEEE802.1ag and ITU-T Y.1731, which are implemented to guarantee SLA as fundamental modules in both products. In addition, this series includes a manageable Carrier Ethernet PoE switches models known as ISCOM2100-PWR series. The ISCOM2100-PWR provide 8-24 PSE+ Fast Ethernet downlink access interfaces (up to 30 Watts per port) with 2/4 x Gigabit combo uplinks. The ISCOM2100-PWR PoE switches offer a power supply for power demand (PD) devices such as wireless Access Point (AP).

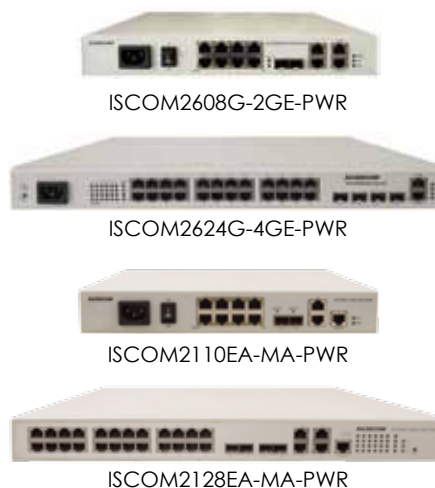

Device	ISCOM2608G-2GE-PWR	ISCOM2624G-4GE-PWR	ISCOM2110EA-MA-PWR	ISCOM2128EA-MA-PWR
Port Type	Uplink: 2 x GE Combo Downlink: 8 x GE RJ45	Uplink: 4 x GE Combo Downlink: 24 x GE RJ45	Uplink: 2 x GE Combo Downlink: 8 x GE RJ45	Uplink: 4 x GE Combo Downlink: 8 x GE RJ45
Switching Capacity	20Gbit/s	56Gbit/s	5.6Gbit/s	12.8Gbit/s
Packet Switch Rate	14.88Mpps	41.66Mpps	4.17Mpps	9.52Mpps
PoE	802.1af/at	802.1af/at	802.1af/at	802.1af/at
MAX POWER	150w	440w	150w	440w

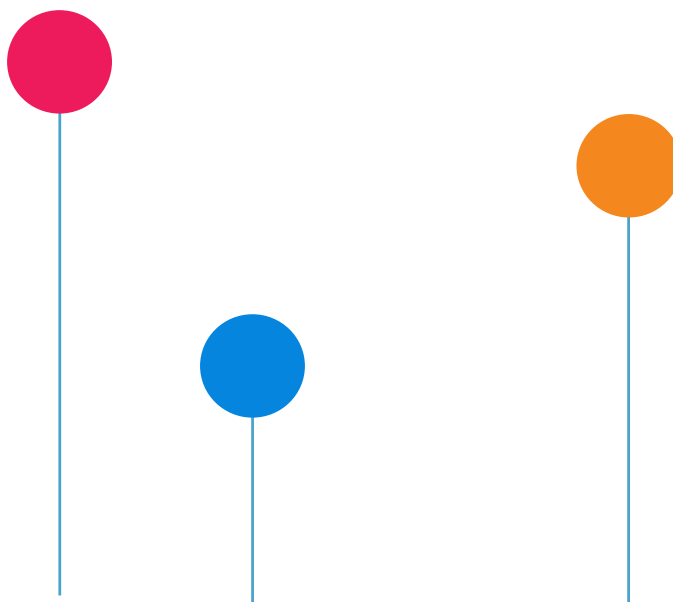

L2&L3 Aggregation Switch

ISCOM3000 Series

The carrier-grade ISCOM3000 L2/L3 aggregation switch has an advanced switching structure that supports IPv4 and IPv6 static route and dynamic route protocols. With flexible networking modes, high reliability, easy maintenance, individualized QoS, various security guarantees, and advanced system management, ISCOM3000 series can fully meet the requirements of any network carriers. The ISCOM3000 series can be used as a large enterprise network aggregator and campus network convergence device, small and medium enterprise network core, data center Gigabit access equipment, and more.

Models: ISCOM3024G-4C, ISCOM3048G-4C, ISCOM3024GF-4C, ISCOM3048GF-4C, ISCOM3024GF-4GE, ISCOM3024G-4GE and ISCOM3048XF-4Q

FEATURE

- High capacity, high density
- ISF Stacking
- MEF CE2.0 Complaint
- OAM
- Individualized QoS
- L2 multicast, IGMPv1/v2/v3
- Rich security guarantees
- IPv4/IPv6
- Route v4/ Route v6
- VRRP
- ECMP
- Policy Routing
- PIMv4/PIMv6
- IP/MPLS
- LDP
- VRF
- L2VPN/L3VPN
- BFD
- SNMP, RMON, Telnet, SSH to increase the usability of the device



ISCOM3048XF-4Q



ISCOM3048G-4C



ISCOM3048GF-4C



ISCOM3024GF-4C



ISCOM3024G-4C

Model	ISCOM3000GF-4C	ISCOM3000G-4C	ISCOM3000GF-4GE	ISCOM3000G-4GE	ISCOM3000XF-4Q
Port Number & Type	24/48 x 100/1000 SFP+ 4 x 10G SFP+	24/48 x 100/1000 RJ-45 + 4 x 10G SFP+	24 x 100/1000 SFP+ 4 x 1G Combo	24 x 100/1000 RJ-45 + 4 x 1G Combo	48 x 10G SFP+ + 4 x 40G QSFP
SNMP Port	1				
Console Port	1				
Size	1U, 19" 440*360*43.6 mm3				1U, 19" 440*420*43.6 mm3
Weight	<6.0kg (24 port models) or <8.0kg (48 port models)		<6.0kg		<9.0kg
Power Supply Mode	AC/D, DC/D, AC_DC (AC: 220V, DC: -48V)				
Dual Power	Support				
MAX Power	65w or 85w	55w or 80w	55W	50W	240W
Voltage Scope	AC 100~240V, DC -36~-72V				
Working Temperature	0-50°C				0-45°C
Store Temperature	-25-60°C				
Working Humidity	10%~90% RH				
Store Humidity	10%~90% RH, no condensation				
Jumbo Frame	12K Bytes				
Buffer	2MB				16MB
Switch Capacity	128Gbps or 176Gbps		56Gbps		1280Gbps
Packets Switch Rate	95.23Mpps or 130.94Mpps		41.66Mpps		960Mpps

Chapter 2. IP MPLS

IP/MPLS provider edge and customer edge products offer high performance MPLS switching & routing and effortless scalability. Raisecom brings all the benefits from an MPLS core all the way to the customer premises, delivering adjustable bandwidth and dedicated SLAs, without increased complexity and expense. Raisecom's ability to deliver cost-effective IP/MPLS all the way to the customer premises allows service providers to optimize network loads, improve performance and reduce on-going costs.

IP-MPLS PE and Pre-Aggregation Product

iTN8800

This medium size IP/MPLS PE router & MPLS Pre-Aggregation device is used for a number of applications such as backhaul FTTH, leased line services, mobile backhaul, and wholesale businesses utilizing aggregation devices on a carrier network. Raisecom offers a cost effective IP/MPLS PE router which fully supports all functionalities and smoothly interoperates with an existing multi-vendors core or aggregation network. The Raisecom PE IP/MPLS router also supports of TDM PWE3 circuit emulation, in order to aggregate legacy TDM services from the customer premises. A single device can provide all the IP/MPLS features and services for a campus network, private network or utility network.



iTN8800 System

FEATURE

- Reliable network assurance with redundant power supplies, NMS cards
- MEF CE 2.0, IP-MPLS and MPLS-TP
- OSPF, ISIS and BGP route protocol
- BFD for OSPF, OSPF for MPLS-TE and CSPF
- MPLS VPWS, VPLS, HVPLS, L3VPN, Multi-Segment PW
- LDP for LSP/PW, MPLS-TP, RSVP-TE
- Global/interface LLDP
- Global/interface RSVP-TE
- Dynamic ARP learn function
- MPLS L3VPN
- L2 and L3 SLA
- IP and MPLS OAM, MPLS-TP OAM
- Synchronization: SYNC-E, 1588v2
- Pseudowire: E1, STM-1 and STM-4

System and Sub-cards

- iTN8800-II-DC, iTN8800-II chassis (includes fan & power module)
- iTN8800-II-NXU, iTN8800-II management & control module
- iTN8800-RG8, iTN8800 8 x GE module (SFP)
- iTN8800-RF8, iTN8800 8 x FE module (SFP)
- iTN8800-RG8T, iTN8800 8 x GE UTP module 10/100/1000
- iTN8800-RXG8, iTN8800 8 x GE UTP and 1 x 10G SFP+ (Slot 7, 8 only)
- iTN8800-RX2, iTN8800 2 x 10GE module
- iTN8800-RE16, iTN8800 16 x E1 (CES-E1) module
- iTN8800-RS4, iTN8800 4 x STM-1 or 1 x STM-4 CES sub card, up to 252 PW tunnels
- iTN8800-TAU, iTN8800 1588v2 clock card

IP-MPLS CPE Product

ISCOM RAX711-R, iTN201-R

The IP/MPLS CPEs extend the functionality of IP/MPLS to the customer premise in order to increase network efficiency and performance. Raisecom's best in breed of IP/MPLS CE enable the creation of an end-to-end MPLS tunnel guaranteeing the best VPN performance conveying all the MPLS VPN benefits to the customers. The RAX711-R, which is the most compact and cost-effective MPLS CE, provides customers an affordable MPLS networks access product. Customers can replace legacy TDM based leased line services, maintaining quality but lowering costs. The IP/MPLS CE products provide performance monitoring at a lower cost than a Layer2 Ethernet device. In addition, it improves the service consistency on the customer's premises with the MPLS tunnel, instead of a low performance router. The IP/MPLS CE products are fully compatible with both the RAISECOM IP/MPLS pre-aggregation PE router as well as equipment from any other vendors on the existing MPLS aggregation network



ISCOM RAX711-R



iTN201-R

P/N	ISCOM RAX711-R	iTN201-2XG-R / iTN201-4GF-R
Interfaces	2 x GE SFP Interfaces uplink, 4 x GE Electrical Interfaces downlink / 4 x GE Combo Interfaces downlink; 4 x E1 Interfaces	iTN201-4GF-R 4 x GE uplinks + 6 to 12 x GE (TSFP) downlinks and 2 sub slots for another 8 x GE downlinks iTN201-2XG-R 2 x GE uplinks + 6 to 12 x GE (TSFP) and 2 sub slots for additional 2 x 10GE and 4 x GE or 8 x GE downlinks
Technical Standards	ITU-T G.8131, G.8031, and G.8032, G.8113.1, and BFD ITU-T Y.1731, IEEE 802.3ah, IEEE 802.1ag IETF RFC5860 and RFC2544 OSPF, BGP, MP-BGP, and VRRP MPLS, LDP, MPLS-TP, and MPLS QoS, IETF RFC4664 L2VPN framework, VPWS, VPLS, and L3VPN	ITU-T G.8131, G.8031, and G.8032 ITU-T Y.1731, IEEE 802.3ah, and IEEE 802.1ag BFD, ITU-T G.8113.1, IETF RFC5860, and IETF RFC2544 TE FRR and VRRP OSPF, BGP, and MP-BGP MPLS, LDP, and MPLS-TP IETF RFC4664 L2VPN framework VPWS, VPLS, and L3VPN MPLS QoS
Dimensions	220 × 43.6 × 180 mm3	440 × 44 × 266 mm3
Power Consumption	<25W	<60W
Operating Environment	Temperature(°C): -5 °C to 65 °C Humidity: 10%–90% RH	Temperature(°C): -5 °C to 50 °C Humidity: 10%–90% RH

Chapter 3. Optical Transport Network

OTN (Optical Transport Network) systems smoothly handle ever-increasing bandwidth demands for data services and also for mobile backhaul, Fronthaul, Inter datacenter connectivity and GPON/EPON extension. They do so by integrating the functionality of transport, multiplexing, switching, protection and management of customer traffic in a single box. Compact OTN systems easily meet the high bandwidth demands of public and private clouds as well as software-defined networks, that require gigabit Ethernet and above. For FTTH and LTE/4G applications, OTN systems allow carriers to save on OPEX and fiber resources when deploying mobile Fronthaul and GPON/EPON.

Multi-Service OTN Platform

iTN8600-II/iTN8600-V

The iTN8600-V and the iTN8600-II are new intelligent all-service access and transmission platforms designed to future-proof networks. The iTN8600 series integrates OTN cross connection, MPLS-TP and SDH features and provides integrated all-service access, and flexible multi-core cross-connection and scheduling. Operators can use it to transport multiple types of services on one platform, including leased line, FTTX, and LTE services. Altogether, it provides a complete solution for MAN access and aggregation.

The iTN8600 is perfect for mobile Fronthaul, enabling mobile operators aiming to minimize OPEX and expand radio coverage. It allows carriers to multiplex up to 30 2/3/4G CPRIs and extend reach to over 25km.

An advanced new chip multiplexes 8 x EPON or 4 x GPON OLT ports into OTU2, and that traffic can be transmitted over a WDM or OTN network over 45km to extend GPON/EPON coverage and to save up to 90% of fiber. Compatible with Raisecom's iTN series products, iTN8600 can be deployed in a point to point and ring topology for various applications. It is commonly used for service provider OTN edge aggregation, mobile backhaul and Fronthaul, data center interconnect as well as high capacity business connectivity. The product can be managed by a GUI-based NView NNM system to simplify configuration and to monitor performance in real-time.



iTN8600 System



iTN8600-v

FEATURE

- Universal switching and flexible grooming for OTN, SDH, and packet services
- Maximum DWDM 40λ* 10G Line capacity;
- 120G packet switching capability
- All service access capability, including E1, STM1/4/16/64, OC-3/12/48/192, FE/GE, 10GE LAN, 10GE WAN and OTU1/OTU2, CPRI/OBSAI, FC-1/2/4/8/10, EPON/GPON etc.
- EP-Line, EVP-Line, EP-Tree, EVP-Tree, EP-LAN, EVP-LAN
- MPLS-TP
- 40G OTN cross-connection based on ODU and ODU1
- Static LSP, L2VPN and VPLS
- Up to 20G cross-connection based on VC4 or 10G cross-connection based on VC3/VC12
- G.8113.1 OAM, 802.1ag/Y.1731/SLA OAM and 802.3ah OAM
- 8 x 1.25G over OTU2 and 4 x 2.5G over OTU2 multiplexer
- Transponder with 5 OTU2 ports on each card
- System management card and power supply module redundancy
- Supports Auto Laser Shutdown (ALS) protection and Dying Gasp
- Redundancy and reliability with one plus one MSP and LPP on OTN side, ITU-T G.8031 (ELPS), G.8032 (ERPS) and LAG protection on Ethernet side, MPLS-TP linear, ring and dual-homing protection on PTN side and 1+1 MSP, SNCP, 1+1 LPP on SDH side
- SNMP (NView compatible) via in-band and out-of-band network channels

System and Sub-cards

Chassis and NMS cards:

- iTN8600-II-DC, 2U/11 slot chassis
- iTN8600-V-DC, 5U/19 slot chassis
- iTN8600-V-NTU, Optical system management card for iTN8600-V chassis
- iTN8600-II-NXU, system management and control card for iTN8600-II chassis
- iTN8600-II-NTU, optical system management and control card for iTN8600-II chassis
- iTN8600-EOW, EOW card, support 2 ways FXS interface.

Muxponder cards:

- iTN8600-AO2D, OTU2 aggregation card with 8 x SFP interface for any services and 2 x OTU2 SFP/XFP interface
- iTN8600-EM2D, OTU2 aggregation card with 16 x GE/FE SFP interface, 2 x 10GE XFP interface at client side and 2 x OTU2/OTU2e/10GE XFP interface at line side

Transponder cards:

- iTN8600-XD2D, OTN tributary card with 2 x OTU2/OTU2e/10GE LAN/10GE WAN/STM64 SFP interface at client side and 2 x OTU2/OTU2e XFP interface at line side
- iTN8600-OTU5, support 2R, 5 paths of two-way wavelength transfer, can be applied for point to point, CWDM, DWDM, and so on
- iTN8600-OTU5E, support 3R, enhance 5 paths of two-way transponder card or 2-channel OCP card, can be applied for point to point, CWDM, DWDM, and so on

Optical cards:

- iTN8600-DM16E, DWDM Mux card, multiplexing up to 16-way single-wavelength optical signals to 1-way multiplexing signals, C21-C36
- iTN8600-DD16E, DWDM Demux card, demultiplexing 1-way multiplexing signals to up to 16-way single-wavelength optical signals, C21-C36
- iTN8600-DMU40, DWDM Mux card, multiplexing up to 40-way single-wavelength optical signals to 1-way multiplexing signals
- iTN8600-DDU40, DWDM Demux card, demultiplexing 1-way multiplexing signals to up to 40-way single-wavelength optical
- iTN8600-OMD8, 8-wavelength Coarse Wavelength Division Multiplexing (CWDM) multiplexing and demultiplexing card
- iTN8600-DAD1D, DWDM single-way dual-fiber bidirectional optical add-drop card
- iTN8600-DAD4D, DWDM four-way dual-fiber bidirectional optical add-drop card
- iTN8600-DAD8, DWDM eight-way dual-fiber bidirectional optical add-drop card
- iTN8600-OLP, optical line one plus one 1+1 protection, can be applied for protection purposes at the client side, line side and multiplex section
- iTN8600-OPA, EDFA optical Pre-amplifier card
- iTN8600-OBA, EDFA optical Booster amplifier card
- iTN8600-OBA20, EDFA optical Booster amplifier card
- iTN8600-OLA20, EDFA optical Line amplifier card
- iTN8600-FDU, OSC card
- iTN8600-OPD, optical power detection card

PTN cards:

- iTN8600-PG8, GE tributary card with 8 x GE/FE SFP interface
- iTN8600-PG8T, GE tributary card with 8 x GE/FE copper interface
- iTN8600-PG16E, GE tributary card, 8 x SFP ports and max 16 GE interfaces with TSFP (two-channel SFP)
- iTN8600-PX2, 10GE tributary card with 2 x 10GE XFP interface
- iTN8600-PE16, E1 CEs sub card to access 16 E1 service simulate to packet service
- iTN8600-PE16-BL, E1 CEs sub card to access 16 E1 service simulate to packet service, E1 120Ohm Balance interface
- iTN 8600-PS4, 4 x STM-1 or 1 x STM-4 CES sub card, up to 252 PW tunnels
- iTN 8600-TAU, IEEE1588v2 clock card

xPON cards:

- iTN8600-LGO2D, OLT-side GPON aggregation-extension card. Map maximum 8 x GPON service into 2 x OTU SFP+ interfaces
- iTN8600-LEO2D, OLT-side EPON aggregation-extension card. Map maximum 8 x EPON service into 2 x OTU SFP+ interfaces
- iTN8600-NO2D, ONU-side EPON/GPON aggregation-extension card. Map maximum 8 x EPON/GPON service into 2 x OTU SFP+ interfaces
- iTN8605-NO2D, ONU-side EPON/GPON aggregation-extension device. Map maximum 8 x EPON/GPON service into 2 x OTU SFP+ interfaces, size 1U, 19''

SDH cards:

- iTN8600-SH2, SDH aggregation card with 2 x STM16 SFP interface
- iTN8600-SS4, SDH tributary card with 4 x STM1/4 SFP interface
- iTN8600-SG16, EOS tributary card with 8/16 x GE/FE SFP interface and 2 x STM4 SFP interface

Chapter 4. Packet Transport Network

The shift from legacy networks to packet transport networks (PTN) and MPLS is continuing due to higher bandwidth, greater flexibility and lower cost offered by next-gen packet switched networks. However, traditional leased line and 2G mobile backhaul businesses still need to be supported by service providers. In addition, utilities and transportation companies continue to use low speed data, analog voice and other specialized equipment and interfaces which need to be supported on the next-gen network. Therefore, the next-generation networks must support existing service models and are required to inherit TDM features including reliability, OAM and synchronization. However, it must still be future-proof to delivery of vast data traffic at an affordable price level, catering to the ever-increasing needs of enterprise users and 3G/4G/LTE mobile backhaul applications.

The Raisecom PTN platforms are a multi-core system that can carry any service over either SDH or IP/Ethernet infrastructures at the same time. They are perfect for enabling a smooth transition from TDM to IP. The SDH-like network protection and redundancy requirements are met by supporting G.8031/G.8032 Ethernet and G.8131/Wrapping-Steering MPLS-TP protection protocols with a recovery time of sub-50ms. Advanced management, monitoring and SLA assurance are implemented using 802.3ah, 802.1ag, Y.1731. For mobile backhaul and other timing sensitive applications, the PTN platforms support SyncE and I588v2. Integrated pseudowire technologies enable smooth migration of TDM and legacy equipment over packet.

Dual-Core Architecture PTN Aggregation Platform

iTN2100

The iTN2100 is a 6U/15-slot, high-capacity, modular PTN platform with a dual-core architecture for both Ethernet and TDM traffic delivery. It enables flexible and profitable deployment of carrier-grade business and mobile backhaul connections, and a smooth evolution from traditional to next-generation services. The iTN2100 supports up to 4 x 10G and/or 4 x STM-4/16 uplink capacities, and provides an efficient cross-connect, integration and transportation options over a wide range of copper/fiber based legacy and IP services. To maximize the uptime and to guarantee the carrier's network availability, iTN2100 supports full hardware redundancy, G.8032/G.8031 Ethernet and G.8131/Wrapping-Steering MPLS-TP protection. Extensive management capabilities are provided for all aspects from equipment installation and service provisioning to real-time system operation and performance monitoring. The iTN2100 offers cost-effective transport of MEF-compliant CE2.0 Ethernet services, E1/T1, 2/4/8-wire SHDSL, fiber multiplexing, and pseudowire connectivity for lease-lined and 2G/3G/LTE mobile backhaul. In addition, the system also supports seamless connections with MPLS-TP and IP-MPLS backbones and converged fixed-mobile infrastructure by adopting SyncE and 1588v2 PTP. With this integrated system, carriers and ISPs can save on CAPEX and OPEX by implementing scalable networks that can easily grow with infrastructure and bandwidth demand in the future.



iTN2100

FEATURE

- Combined dual cores can deliver Ethernet and TDM traffic in one system
- Available with 4 x 10G XFP and 4 x GE SFP, or 8 x GE SFP at line side and up to 128 x GE TSFP at client side
- Available with 4 x STM16 SFP or 4 x STM1 SFP at line side and up to 40 x STM1 SFP at client side
- Available with STM-1, EoTDM, PWE3, FiberMux, FE, DS3, E3, E1, Voice, V.35, V.24, RS232, G.SHDSL.bis at client side
- E-Line, E-LAN and E-Tree are compliant with CE2.0 relevant MEF specifications
- Uplink redundancy and resiliency with ITU-T G.8031 (ELPS), G.8032 (ERPS) on Ethernet side, G.8131 MPLS-TP liner protection and Wrapping/Steering MPLS-TP ring protection on PTN side and 1+1 liner MSP, SNCP, 1+1 LPP on SDH side
- IEEE802.3ah, 802.1ag, ITU-T Y.1731/SLA, L2MPLS-TP LSP/PW/section OAM
- VLAN, QinQ, QoS, LACP, and static MPLS compliant with MPLS-TP
- PWE3 tributary card supports SAToP, CESoP, MPLS, CESoETH (MEF) and UDP/IP encapsulations
- Port statistic based on VLAN/EVC/COS
- Compliant with 1588v2 (PTP) OC/BC/TC mode and SyncE
- Optional 2Mbit, 2MHz input/output external clock
- Full hardware redundant protections for GE, PWE3, SDH, Multi-service FiberMux sub-cards and power supply
- OAM for remote CPE management
- Auto Laser Shutdown (ALS) protection and Dying Gasp
- SNMP (NView compatible) via in-band and out-of-band network channels

System and Sub-cards

- iTN2100-12-A, 6U/15-slot chassis with ventilation modules only
- iTN2100-NMS, system management and control card
- iTN2100-NTU-2XG, 10G aggregation card with 2 x 10G XFP interfaces and 2 x GE SFP interfaces
- iTN2100-NTU-4GF, GE aggregation card with 4 x GE SFP interfaces and 1+1 card protection
- iTN2100-TSU, Clock card providing both IEEE1588(PTP) and SYNC-E
- OPCOM3500E-2STM1/4-M, SDH aggregation card with 2 x STM1 or 2 x STM4 SFP interfaces
- iTN2100-16GF, GE tributary card with 8 x SFP slots supporting 16GF with TSFP-Gb, 16FX with TSFP-03, and 8 x GF with SFP-Gb
- iTN2100-8FX, GE tributary card with 8 x FE SFP interfaces
- iTN2100-8EOS-8GF, EoS tributary card with 8 x GE SFP interfaces enabling a Gigabit Ethernet service delivery over 8 x VCG
- iTN2100-CES-STM1/4, PWE3 tributary card with 4 x STM1 or 1 x STM4 SFP interfaces
- iTN2100-CES-16E1T1-BL, PWE3 tributary card with 16E1/T1 interfaces
- OPCOM3500E-16E1 - 16 E1 card
- OPCOM3500E-32E1 - 32 E1 card
- OPCOM3500E-DXC-DS0 - DS0 based timeslot cross connection module
- OPCOM3500E-TP, four pairs of optical interface for C37.94 service
- OPCOM3500E-DC64K, G.703 tributary unit, 16 x ports

- OPCOM3500E-10E&M, 2/4wire E&M card with 10 interfaces
- OPCOM3500E-Audio, 16 port FXS or FXO module
- OPCOM3500E-MULTI, Multi low speed service tributary card, provide 8 voice (FXS/FXO) interfaces, 4 audio interfaces with and 4 data (RS232/V.24 or RC485/422) interfaces
- OPCOM3500E-8V35, 8 x V35 module

Compact PTN Aggregation Platform

iTN221

The iTN221 is a "Pizza Box" 1.5U (full ETSI) sized, next generation multiservice access node. It offers a dual core architecture for both packet and SDH/TDM transmission.

The iTN221 supports up to 2 x 1G and/or 2 x STM-1/4 uplink capacities, and a built-in PDH multiplexer function, DXC non-blocking clock cross connect matrix at 64K level and TDM pseudo-wire functionality for TDM to Ethernet/IP/MPLS service migration.

The iTN221 supports three service slots suitable for various sub cards: Voice (FXS/FXO/E&M), Ethernet (GE/FE), C37.94, 64K codirectional, Data V35/x21, RS232/RS485 etc.

It provides utilities and transportation companies with reliable connectivity for controlling signals, mission critical data, voice, video monitoring and electrical protection services. It supports the smooth transition from PDH, SDH to the packet transmission network.

For mission critical services, the system maximizes uptime and provides carrier-class network availability using G.8032/G.8031 Ethernet and G.8131/Wrapping-Steering MPLS-TP protection that provide sub-50msec recovery as well as hot swappable redundant power supplies... Extensive management capabilities are provided for all aspects from equipment installation and service provisioning to real-time system operation and performance monitoring. The iTN221 offers a cost-effective solutions for providing MEF-compliant CE2.0 Ethernet services, as well as E1 and pseudowire connectivity for lease-lined and 2G/3G/LTE mobile backhaul .with integrated SyncE and 1588v2 PTP. Altogether, the iTN201 can be used to reduce CAPEX and OPEX and build a future-proof infrastructure that can scale both in capacity as well as migrate additional services to packet infrastructure without further equipment investment.



iTN221

FEATURE

- Combined dual cores can deliver Ethernet and TDM traffic in one system
- Available with 2 x 1G SFP uplink, 4 x GE in the mainboard and 4 x GE subcard module (with PoE)
- Available with 2 x STM-1/4 SFP
- Available with E1 TDM, E1 PWE3, GE, Voice, V.35, V.24/RS232, TP and 64K Codirectional at client side
- E-Line, E-LAN and E-Tree are compliant with CE2.0 relevant MEF specifications
- Uplink redundancy and resiliency with ITU-T G.8031 (ELPS), G.8032 (ERPS) on Ethernet side, G.8131 MPLS-TP liner protection and Wrapping/Steering MPLS-TP ring protection on PTN side and 1+1 liner MSP, SNCP, 1+1 LPP on SDH side
- IEEE802.3ah, 802.1ag, ITU-T Y.1731/SLA, L2MPLS-TP LSP/PW/section OAM
- VLAN, QinQ, QoS, LACP, and static MPLS compliant with MPLS-TP
- PWE3 tributary card supports SAToP, CESoP, MPLS, CESoETH (MEF) and UDP/IP encapsulations
- Compliant with 1588v2 (PTP) OC/BC/TC mode and SyncE
- 2Mbit, 2MHz input/output external clock
- Dry contact Alarm Relay (Input/output alarms)
- Extended temperature range (-20 to 65°C)
- Environmental Standards: CE, UL, EN 50121-4, IEC61000-4-2/3/4/5/6/7/8/9, 11/12/13/14, 29 IEC61850-3
- SNMP (NView compatible) via in-band and out-of-band network channels

System and Sub-cards

- iTN221-4GE, including the chassis, main card, double power, fans, and three sub card slot
- The main card includes : 2 x STM-1/4, 2 x GE uplinks, 8 x E1's and 4 x GE user
- iTN221-SUB-V35/ x 21, V.35/ X 21 subcard, 1 x ports
- iTN221-SUB-DC64K, G.703 codirectional subcard, 4 x ports
- iTN221-SUB-RS24, Serial interface subcard, Provides Four V.24/RS232/RS485
- iTN221-SUB-TP, C37.94 subcard. Support two pairs of optical interface for C37.94 service. Support standalone, or • configuration for protection. Bandwidth is Nx64k (N=1~12) every channel
- iTN221-SUB-10FXS/0, FXS/FXO subcard, 10 x ports
- iTN221-SUB-4GE, Provides four GE service ports and including two POE interface. The system can only use one card
- iTN221-SUB-4E1, E1 subcard, 4 x ports
- iTN221-SUB-4E & M, E&M subcard, 4 x ports
- iTN221-SUB-8MT, 8 magneto channels

P/N	iTN2100	iTN221
Chassis(high)	6U	1.5U
Number of Service slots	13	3
SDH cross-connect	86 x 86 VC4 or 4032 x 4032 VC12	8 x 8 VC4 or 504 x 504 VC12
Packet switch capacity	48G	16G
STM-16 interface	4	N/A
STM-1/4 interface	4	2
E1 channel	320	20
DS3/E3 channel	30	N/A
PDH optical tributary channel	40	N/A
EOS interface	80	8
FE port	80	8
GE port	352 x GE for tributary, 16 x GE for aggregator	8
10GE port	4	N/A
PWE3	8 x STM4/32 x STM1	N/A
	128 x E1/T1	20 x E1/T1
PCM Interfaces : FXS/FXO/E&M, V24/RS232, C37.94, V35, G.703 CoDir	Yes	Yes
G.SHDSL interface	80	N/A

TDM over Ethernet/IP/MPLS

RC1201-2GE16E1T1, RC1201-4FE4E1T1(-O), RC1201-2FEE1T1, RC1201-2FEV35

Raisecom offers an end to end solution for transporting Ethernet over TDM/IP/MPLS including both CPEs and aggregation devices. When working in pairs or with aggregation nodes, the RC1201 series can extend the TDM traffic transparently over the Ethernet, UDP/IP, MEF or MPLS Packet Switched Networks (PSNs). The RC1201 series offers a configurable jitter buffer that enables smooth compensation for the delay variation introduced by the PSN. All of RC1201 series support four clock modes and two Ethernet payload encapsulations. The aggregation models offer an optional clock sub-card to recover the external clock. The RC1201 series supports advanced traffic management such as flow control, fault propagation, rate-limit, tagging, stacking and filtering (in addition to a full suite of OAM functionality). All the PWE3 demarcation devices support in-band and out-of-band management, and can be configured locally via CLI, Telnet, or SNMP (NView compatible).

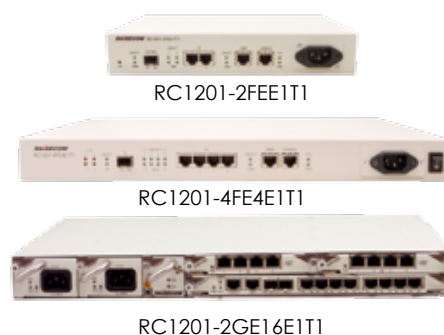

P/N	RC1201-2GE16E1T1	RC1201-4FE4E1T1	RC1201-2FEE1T1	RC1201-2FEV35
Interface	Client: 16 x E1/T1 + 8 x GE (GE cards are inserted in 2 expansion slots) Line: 2 x GE SFP Management: 1 x Console + 1 x SNMP	Client: 4 x FE + 4 x E1/T1 Line: 1 x GE SFP Management: 1 x Console + 1 x SNMP	Client: 2 x FE + 1 x E1/T1 Line: 1 x GE SFP Management: 1 x Console + 1 x SNMP	Client: 2 x FE + 1 x V.35 Line: 1 x GE SFP Management: 1 x Console + 1 x SNMP
MTU	12,288 Bytes	1632 Bytes		
Ethernet	16k MAC, VLAN, QinQ	8k MAC, VLAN, QinQ		
IP service	N/A			
MPLS-TP	64 PW			
TDM PW encapsulation	MEF8, MPLS-TP, UDP/IP, SAToP, CESoPSN	MEF8, MPLS-TP, UDP/IP, SAToP, CESoPSN, HDLC and AAL1		MEF8, MPLS-TP, UDP/IP, SAToP, HDLC and AAL1
TDM interface	Unframed and framed modes			V.35 phase and clock mode configurable Bandwidth: Nx64Kbit/s (N=1~64)
Clock/Synchronization	Internal/slave/adaptive clock configurable			Internal/loopback/adaptive clock configurable
Traffic Management	Stream-marked based on CoS and DSCP, SP, WRR and DRR queue schedule and 8 queues per port Rate limit per port/VLAN	Stream-marked based on Cos and DSCP, SP and WRR queue schedule and 4 queues per port, Rate limit per port		
Ethernet OAM	IEEE802.3ah OAM			
Reliability & Protection	Link aggregation group Loop detection per port/VLAN	Link aggregation group Loop detection per port		
Security	ACL based on MAC Storm control (broadcast, multicast, DLF)			
System Management	CLI, Telnet and SNMP (NView compatible)			

Chapter 5. xPON

GPON & EPON networks provide high throughput point-to-multipoint connections from the Point of Presence (POP) to the customer premise. It can be profitably used in massive deployments of triple-play services as it offers a low CAPEX and OPEX. It is also possible to optimize TCO when fiber resources are limited, by deploying point-to-point active optical networks. The Raisecom xPON product line supports both the EPON and 10G-EPON technologies introduced by IEEE, as well as the GPON and XG-PON technologies introduced by ITU. The former offers a GE or 10G symmetric bit rate, while the latter offers asymmetric 2.5GE/10G downstream and 1.25GE/2.5GE upstream bit rates.

The Raisecom GPON/EPON portfolio consists of high and low densities and standalone OLT chassis and diverse ONT models for subscribers in single family units (SFUs) and multi-dwelling units (MDUs). The Raisecom GPON line offers a wide array of chassis optimized for low subscriber counts in rural and suburban areas, as well as high density models for urban areas. The entire line can be deployed in a 'pay as you grow' model, with modules added as subscriber counts increase, continuously maintaining service providers' profitability. The Raisecom PON system enables transmission of native Ethernet services from backbones to the "last mile". The products ensure easy provisioning, remote management, high performance and network redundancy, and, most importantly, guarantee a profitable business case for FTTH network builders

XPON OLT

ISCOM6800

ISCOM6800 is a 13U high-density integrated platform compatible with both IEEE802.3ah EPON and ITU-T G.984 GPON standards. The system can aggregate a maximum of 14,336 ONUs/ONTs with a typical 1:64/1:128 split ratio. ISCOM6800 also possesses great switching capacities and can be used to aggregate and transport data, voice and video traffic from other OLTs over Ethernet backbones. Enhanced network manageability, reliability and redundancy are supported with Ethernet OAM, CFM functions, ring protection mechanisms, and a hot-swappable redundant power supply. ISCOM6800 also supports multi-purpose access and aggregation PON and xDSL DSLAM Ethernet traffic at the same time.



ISCOM6800

FEATURE

- Available with mixed pluggable up to 224 x GE or 8 x 10GE interfaces for uplink, and up to 112 x GPON or 224 x EPON interfaces for downlink
- 2 x SMC control module supporting real-time redundancy
- Up to 1:64/1:128 split ratio, and 14,336 ONUs per full-load 10U OLT chassis
- Upstream wavelength of 1310nm and downstream wavelength of 1490nm
- IEEE 802.3ah (EPON), ITU-T G.984 (GPON), IEEE 802.3av (10G EPON)
- Symmetrical 10G/10G or asymmetrical 10G/1G
- Storm control of broadcast, multicast and DLF
- Trunk group and Link Aggregation Control Protocol (LACP)
- 1+1 automatic protection and link diagnostic for each PON port
- VLAN, QinQ, QoS, DBA and a reliable SLA
- IEEE802.3ah/802.1ag, /SLA/G.984
- IGMP, Multicast VLAN Registration (MVR), DHCP and Option 82
- AES-128 encryption and triple churning
- Hot-swappable redundant power supply
- CLI, Telnet, SSHv2 and SNMP (NView compatible)

System and Sub-cards

- ISCOM6800-18-A, 13U/18-slot chassis with an airflow slot and only a cable array
- ISCOM6800-SMCA, system management and control card with a switching capacity of 1.28Tbps
- ISCOM6800-SMCB, system management and control card with a switching capacity of 640Gbps
- ISCOM6800-EP16, EPON service card with 16 x EPON SFP interfaces
- ISCOM6800-EP12, EPON service card with 12 x EPON SFP interfaces
- ISCOM6800-GP8A, GPON service card with 8 x GPON SFP interfaces (under development)
- ISCOM6800-XP4A, 10GE service card (semi-card) with 4 x 10GE XFP plus and interfaces
- ISCOM6800-XP2A, 10GE service card (semi-card) with 2 x 10GE XFP and interfaces
- ISCOM6800-GE16, GE service card with 16 x GE SFP interfaces
- ISCOM6800-CICA, environment monitoring card
- ISCOM6800-GP16, 10G EPON sub card

XPON OLT

ISCOM6860

ISCOM6860 is a 6U medium-density integrated platform compatible with both IEEE802.3ah EPON and ITU-T G.984 GPON standards. The system can aggregate a maximum of 14,336 ONUs/ONTs with a typical 1:64/1:128 split ratio. ISCOM6860 also possesses great switching capacities and can be used to aggregate and transport data, voice and video traffic from other OLTs over Ethernet backbones. Enhanced network manageability, reliability and redundancy are supported with Ethernet OAM, ring protection mechanisms, and a hot-swappable redundant power supply. ISCOM6860 also supports multi-purpose access and aggregation PON and xDSL DSLAM Ethernet traffic at the same time. The ISCOM6860 targets the FTtx, HFC bidirectional transformation, mobile backhaul, IP leased line interconnection, and etc. scenarios.



ISCOM6860

FEATURE

- Available with mixed pluggable up to 112 x GE or 4 x 10GE interfaces for uplink, and up to 112 x GPON or 112 x EPON interfaces for downlink
- 2 x SMC control module supporting real-time redundancy
- Up to 1:64/1:128 split ratio, and 14,336 ONUs per full-load 10U OLT chassis
- Upstream wavelength of 1310nm and downstream wavelength of 1490nm
- IEEE 802.3ah (EPON), ITU-T G.984 (GPON), IEEE 802.3av (10G EPON)
- Symmetrical 10G/10G or asymmetrical 10G/1G
- Storm control of broadcast, multicast and DLF
- Trunk group and Link Aggregation Control Protocol (LACP)
- 1+1 automatic protection and link diagnostic for each PON port
- VLAN, QinQ, QoS, DBA and a reliable SLA
- IGMP, Multicast VLAN Registration (MVR), DHCP and Option 82
- AES-128 encryption and triple churning
- Hot-swappable redundant power supply
- CLI, Telnet, SSHv2 and SNMP (NView compatible)

System and Sub-cards

- ISCOM6860-10, 6U/10-slot chassis with an airflow slot and only a cable array
- ISCOM6800-SMCA, system management and control card with a switching capacity of 1.28Tbps
- ISCOM6800-EP16, EPON service card with 16x EPON SFP interfaces
- ISCOM6800-XP8, 10G EPON access card, providing 8 10G EPON XFP interfaces, applicable to general service slots
- ISCOM6800-GP8A, GPON service card with 8 x GPON SFP interfaces
- ISCOM6800-GP16, GPON service card with 16 x GPON SFP interfaces
- ISCOM6800-XP4A, 10GE service card (semi-card) with 4 x 10GE XFP plus and interfaces
- ISCOM6800-GE16, GE service card with 16 x GE SFP interfaces

EPON OLT

ISCOM5800E

The ISCOM5800E is a 7U medium-sized EPON OLT system. It provides a cost-effective solution for triple-play service delivery over long distances in rural residential areas, along with powerful routing and switching capabilities. It can be used as part of a concentrated transportation ring or as an aggregated standalone OLT for up to 2,560 ONUs at a split ratio of 1:64. The ISCOM5800E is designed for growing bandwidth demands and assists FTTH network owners by improving operational revenues and leveraging their capital investments.



ISCOM5800E

FEATURE

- Available with a mixed pluggable module up to 40 x GE and 4 x 10GE interfaces for uplink and up to 40 x EPON interfaces for downlink
- 2 x SMC control module supporting real-time redundancy
- Up to 1:64 split ratio, 20km transmission distance and 2,560 ONUs per full-load 6U chassis
- Upstream wavelength of 1310nm and downstream wavelength of 1490nm
- ITU-T G.8032 Ethernet Ring Protection Switching (ERPS) with a sub 50ms recovery time
- Storm control of broadcast, multicast and DLF
- Trunk group and Link Aggregation Control Protocol (LACP)
- 1+1 automatic protection and link diagnostic for each PON port
- VLAN, QinQ, QoS, DBA and assured SLA
- IEEE802.3ah, 802.1ag, ITU-T Y.1731/SLA
- IGMP, Multicast VLAN Registration (MVR), DHCP and Option 82
- AES-128 encryption and triple churning
- Hot-swappable redundant power supply
- CLI, Telnet, SSHv2 and SNMP (NView compatible)

System and Sub-cards

- ISCOM5800E-15-A, 7U/15-slot chassis with integrated ventilation module only
- ISCOM5800E-SMCB, system management, and control card containing a switching capacity of 176Gbps
- ISCOM5800E-EP4A, EPON service card with 4 x EPON SFP interfaces
- ISCOM5800-2PON, EPON service card with 2 x EPON SFP interfaces
- ISCOM5800E-GE8A, GE service card with 8 x GE SFP interfaces
- ISCOM5800-4GE, GE service card with 4 x GE combo interfaces
- ISCOM5800-2GE, GE service card with 2 x GE combo interfaces
- ISCOM5800E-10GEX2-2GE, 10GE service card with 2 x 10GE XFP and 2 x GE SFP interfaces
- SUB-PWRM-DC, intelligent power supply card with voltage monitoring and alarm, -48V DC
- SUB-PWRM-AC, intelligent power supply card with voltage monitoring and alarm, 220V AC

Standalone EPON OLT

ISCOM5508

The ISCOM5508 is a full modular compact EPON OLT device typically applied to a business E-LAN, E-Line service delivery, or triple-play extensions for residential areas with a small population. The product offers broad management and monitoring features by supporting 802.3ah EFM, 802.1ag. Enhanced network security is also achieved using 802.1x, RADIUS and TACACS+ authentication processes. The ISCOM5508 can support a transmission distance of up to 20km and 768 ONUs with a split ratio of 1:64. Its modular design ensures flexibility for future expansions and upgrade with a low TCO.



ISCOM5508

FEATURE

- Available with 6 x GE interfaces for uplink and 12 x PON ports for downlink
- Up to 1:64 split ratio, 20km transmission distance and 768 ONUs per full-load 1U chassis
- An upstream wavelength of 1310nm and downstream wavelength of 1490nm
- Storm control of broadcast, multicast and DLF
- Trunk group and Link Aggregation Control Protocol (LACP)
- 1+1 automatic protection and link diagnostic for each PON port
- VLAN, QinQ, QoS, DBA and a reliable SLA
- IGMP, Multicast VLAN Registration (MVR), DHCP and option 82
- Radius and TACACS+
- Hot-swappable redundant power supply
- CLI, Telnet, SSHv2 and SNMP (NView compatible)

P/N	ISCOM6800	ISCOM5800E	ISCOM5508
Ethernet Interface	Up to 224 x GE or 8 x 10G interfaces	Up to 40 x GE and 4 x 10G interfaces	Up to 6 x GE interfaces
EPON Interface	Up to 224 x EPON interfaces	Up to 44 x EPON interfaces	Up to 12 x EPON interfaces
GPON Interface	Up to 112 x GPON interfaces	N/A	N/A
ONUs	Supports up to 14,336 ONUs/ONTs	Supports up to 2,560 ONUs	Supports up to 786 ONUs
Split Ratio	1:64 – EPON 1:128 – GPON	N/A	1:64
Transmission Distance	20km		
VLAN	Supports VLAN, QinQ, QoS, DBA and assured SLA		
TCP/IP	Supports IGMP, Multicast VLAN Registration (MVR), DHCP and Option 82		
Ethernet Ring	N/A	Supports ITU-T G.8032 Ethernet Ring Protection Switching (ERPS) with a 50ms recovery time	N/A
OAM	Supports IEEE802.3ah, 802.1ag, ITU-T Y.1731/SLA		
Security & Reliability	<ul style="list-style-type: none"> • Supports storm control of broadcast, multicast and DLF • Supports one-plus-one automatic protection and link diagnostic for each PON port • Supports AES-128 encryption and triple churning 		<ul style="list-style-type: none"> • Supports storm control of broadcast, multicast and DLF • Supports one-plus-one automatic protection and link diagnostic for each PON port • Supports Radius and TACACS+
Management	CLI, Telnet, SSHv2 and SNMP (NView compatible)		

EPON ONU

ISCOM HT803, ISCOM HT803-1GE, ISCOM HT803-U, ISCOM HT803-W

The Raisecom EPON ONU family, ISCOM HT803, is a series of plastic-box ONUs typically used for residential triple-play services. It offers a wide selection of service ports: Gigabit/Fast Ethernet interfaces, POTS (FXS), CATV RF interfaces and Wi-Fi. The HT803 series supports management via SNMP and can work seamlessly with Raisecom OLTs to deliver high-quality voice, data and CATV services. The ISCOM HT803-W, in particular, can act as a wireless home gateway and can sustain up to 4 SSIDs.



P/N	ISCOM HT803-1GE	ISCOM HT803	ISCOM HT803-W	ISCOM HT803-U
WAN Interface	1 x PON port, up to 20km transmission distance at maximum symmetric rate of 1.25Gbps			
LAN Interface	1 x GE interface + 3 x FE interfaces			
FXS	N/A		2 x FXS Interfaces(RJ11)	
WLAN Interface	N/A		1 802.11 b/g/n	
CATV	N/A		1 x RF	
USB	N/A		1 x USB 2.0	
VLAN, QinQ	Supports VLAN, QinQ, QoS, DBA and a reliable SLA		Supports VLAN, QoS, DBA and a reliable SLA	
Resiliency	Supports link diagnostic for each PON port			
Security	Supports storm control of broadcast, multicast and DLF		Firewall, Access control, Anti-DOS attack, illegal Packet detection,, URL filter, MAC address filter	
OAM	Supports IEEE802.3ah			
Multicast	IGMP v1, v2			
IP route	N/A		PPPoE, DHCP Server/Client,NAT, static route, ALG, UPnP	
Management	Web management and SNMP (NView compatible)		Web management, TR069	

EPON MDU

ISCOM5100 series / ISCOM6100 series

Raisecom MDU series products are targeting the FTTB market in cases of fiber access to the building and copper access inside the building. The MDU series includes data-only model, data and voice model, normal power supply and reversal power supply model. Built with iron shell design, the MDU series is strong in structure, durable and suitable for harsh environment. The built-in power supply ensures a high level of security and lightning proof.

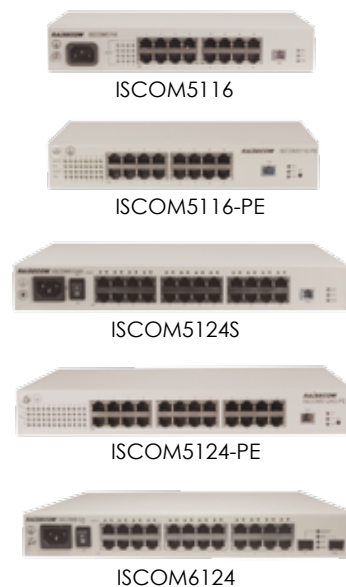

FEATURE

- Iron shell, very strong and durable in harsh environment, high security and lightning proof
- Supports PoE or PoE+ standard
- Strong QoS capacity, multiple traffic classification and schedule mode
- MAC address capacity up to 8k and multi-cast address capacity up to 256
- Telnet, local serial port, Web, SNMP, OAM, etc. management mode
- Multiple uplink modes for customer: EPON uplink, SFP uplink, RJ45 100M uplink, EPON uplink and SFP downlink cascade

Series	Type	Part No.	Interface
EPON MDU ISCOM51xx series (Metal Box)	MDU	ISCOM5108(-PE)	1 x PON + 8 x FE + (PoE)
		ISCOM5116(-PE)	1 x PON + 16 x FE + (PoE)
		ISCOM5124S(-PE)	1 x PON + 24 x FE
10G EPON MDU	MDU	ISCOM6104	1 x 10G EPON + 4 x GE
		ISCOM6124-FE	1 x 10G EPON + 24 x FE
GPON MDU ISCOM51xx-GP series (Metal Box)	MDU	ISCOM5116-GP	1 x GPON + 16 x FE
		ISCOM5124S-GP	1 x GPON + 24 x FE

Standalone GPON OLT

ISCOM6820-GP

ISCOM6820-GP is a 2U small density OLT that complies with the GPON's ITU-T G.984 standard. The device can support up to 32 GPON, 10 GE and up to 4 x 10G ports. The ISCOM6820-GP can aggregate a maximum of 4096 ONUs/ONTs in a typical splitting ratio of 1:128.

The complete modular design of the ISCOM6820-GP enables excessive flexibility in deploying, maintaining and expanding services at reduced CAPEX and TCO. Designed for large enterprises, SME and residential fiber access, the ISCOM6820-GP offers a broad range of features delivering triple-play services, simplifying management, and providing high network reliability. Security is assured by implementations of RADIUS and/or TACACS+, while maximum network uptime is guaranteed by a ring protection mechanism, real-time monitoring and hot-swappable redundant power supplies.



ISCOM6820-GP

Cards and Sub cards

• The device comprises a basic service card with controller and 16x GPON ports Service Slot:

- 16x GPON expandable card , ISCOM6800-GP16
- 16x GE card, ISCOM6800-GE16

Two Uplink slots for 10GE ports

FEATURES

- Available with up to 32 x GPON ports
- Up to 1:128 split ratio, 20km transmission distance and 4096 ONUs per full-load 2U chassis
- An upstream wavelength of 1310nm and a downstream wavelength of 1490nm
- VLAN, QinQ, QoS, DBA and SLA
- Link diagnostic, port backup/isolation/protection/monitoring, bi-directional FEC
- ARP, DHCP relay, DHCP v4/v6, IGMP snooping v1/v2/v3, IPv4, IPv6
- ACL based on MAC, ACL map, port-based mirroring
- Anti-DDoS, RADIUS, TACACS+, Storm control
- RIP v1/v2, OSPF, Service classification per port/VLAN/CoS (DSCP)
- SP, WRR, DRR and SP+WRR scheduling modes
- SFP digital diagnostic (DDM), FAN, CPU, voltage and temperature monitoring
- ITU-T G.984 (GPON), Services OAM, ITU-T G.8021
- CE and RoHS compliant, RMON I and II standards
- CLI, Telnet, SSHv2 and SNMP (NView compatible)

Standalone GPON OLT

ISCOM5508-GP

The ISCOM5508-GP is a compact GPON OLT with enhanced functionality that complies with the GPON's ITU-T G.984 standard. The device can support up to 8 GPON, 10 GE and 2 x 10GE interfaces. The complete modular design of the ISCOM5508-GP enables excessive flexibility in deploying, maintaining and expanding services at reduced CAPEX and TCO. Designed for large enterprises, SME and residential fiber access, the ISCOM5508-GP offers a broad range of features delivering triple-play services, simplifying management, and providing high network reliability. Security is assured by implementations of RADIUS and/or TACACS+, while maximum network uptime is guaranteed by ring protection, real-time monitoring and hot-swappable redundant power supplies. In parallel, the ISCOM5508-GP device supports multi-purpose access and aggregation PON and xDSL DSLAM Ethernet traffic.



ISCOM5508-GP

Sub-cards

- ISCOM5508-GP4A, GPON expandable slot
- ISCOM5508-GE4B, GE expandable slot
- RPA1101-SI-220S12-Fn, hot-swappable AC power supply
- RPD1101-48S12-Fn, hot-swappable DC power supply
- FANS306, Hot-swappable intelligent fan

FEATURES

- Available with up to 12 x GE and 2 x 10G interfaces, or 8 x GPON ports
- Up to 1:128 split ratio, 20km transmission distance and 1,024 ONUs per full-load 1U chassis
- An upstream wavelength of 1310nm and a downstream wavelength of 1490nm
- VLAN, QinQ, QoS, DBA and SLA
- Link diagnostic, port backup/isolation/protection/monitoring, bi-directional FEC
- ARP, DHCP relay, DHCP v4/v6, IGMP snooping v1/v2/v3, IPv4, IPv6
- ACL based on MAC, ACL map, port-based mirroring
- Anti-DDoS, RADIUS, TACACS+, Storm control
- RIP v1/v2, OSPF, Service classification per port/VLAN/CoS (DSCP)
- SP, WRR, DRR and SP+WRR scheduling modes
- SFP digital diagnostic (DDM), FAN, CPU, voltage and temperature monitoring
- ITU-T G.984 (GPON), ITU Y.1731/SLA Services OAM, ITU-T G.8021
- CE and RoHS compliant, RMON I and II standards
- CLI, Telnet, SSHv2 and SNMP (NView compatible)

GPON ONT

ISCOM HT803G-1GE/803G/803G-W/803G-U

The Raisecom GPON optical network terminal (ONT) series provides a flexible mix of residential access services including high speed data, IPTV, voice and CATV services compliant with the ITU-T G.984 standard. In particular, the Raisecom ONUs are designed for Ethernet data services, voice over IP, IPTV, CATV, wireless router accessing and convenient USB2.0 home network storage connections for various application scenarios, such as residential triple-play service and business connections. The GPON ONT series offer flexible choices in terms of downlink types and numbers, such as, GE/FE auto-adapting Ethernet ports, POTS (FXS) interfaces, RF port and WiFi function compliant with IEEE 802.11b/g/n. All GPON FTTH ONUs offer advanced end-to-end management and monitoring functionality, and the GPON series can be managed under the Raisecom NView platform.



P/N	ISCOM HT803G-1GE	ISCOM HT803G	ISCOM HT803G-W	ISCOM HT803G-U
WAN Interface	1 x PON port, up to 20km transmission distance with a 2.5G downstream and 1.25G upstream rates			
LAN Interface	1 x GE interface	4 x GE interfaces		
POTS	N/A		2 x FXS	
CATV	N/A		N/A	1 x RF
USB	N/A			
WLAN	N/A		Home gateway. Support wireless 802.11b/g/n and allow up to 4 SSIDs	
VLAN, QinQ	Supports VLAN, QinQ, QoS, DBA and assured SLA			
Resiliency	Supports link diagnostic for each PON port			
Security	Supports storm control of broadcast, multicast and DLF			
OAM	Supports IEEE802.3ah, 802.1ag, ITU-T Y.1731/SLA			
Multicast	Supports IGMP v1/v2/v3			
TCP/IP	N/A		Supports PPPoE, NAT, NAPT and DHCP	
Management	Telnet, CLI and SNMP (NView compatible)		Web management, Telnet, CLI and SNMP (NView compatible), TR69	

PON Extender

ISCOM GPR01/ISCOM EPR01

ISCOM GPR01/ISCOM EPR01 are used in GPON/EPON networks to extend distance up to 45km. These devices are used to amplify optical signals between OLT and ONU in ODN link, to extend transmission distance and increase optical ratio.

The ISCOM GPR01/ ISCOM EPR01 adapt the OEO (Optical Electrical Optical) regeneration technology to recognize 3R (Regeneration, Reshaping, Re-timing), amplify GPON line optical ratio, extend transmission distance, and increase the splitter ratio. These devices are small and exquisite, are easy to install, and can be widely applied in GPON/EPON system markets such as, broadcast network, carrier network, electricity and traffic network, enterprise network and more.



FEATURES

- Signal amplification that can regenerate, reshape, and retime
- Can extend transmission distance up to 45km
- Increases optical splitter ratio

P/N	ISCOM GPR01	ISCOM EPR01
Dimension	200 x 130 x 32 mm3	100 x 100 x 25 mm3
Weight	0.75kg	0.25kg
Consumption	10W	4W
Transmission Distance	40km	45km
Central Wavelength	1310nm Tx, 1490nm Rx	
Transmission Speed	1.25Gbit/s uplink and 2.5Gbit/s downlink	1.25Gbit/s uplink burst signal and 1.25Gbit/s downlink continued signal
Standard	ITU-T G.984.x	N/A
OLT Interfaces	Rx sensitivity: -28dBm Min. overload: -8dBm Tx optical power: 0.5dBm~5dBm	Rx sensitivity: -27dBm Min. overload: -3dBm Tx optical power: -1dBm~4dBm
GSFP optical module	Rx sensitivity: -28dBm Min. overload: -8dBm Tx optical power: 1.5dBm~5dBm	Rx sensitivity: -30dBm Min. overload: -6dBm Tx optical power: 2dBm~7dBm

CATV EDFA

RC5832B-08, RC5832B-16

The fiber amplifier is a 2U rack-mount device with a dual-power backup chassis. It provides 16 or 4 data ports and 1 CATV port input simultaneously and 16 or 4 data + CATV mixed signal output ports. Users from the remote side can query and configure the states and parameters through the display of the Raisecom's panel, control button and NMS.



RC5832B

FEATURES

- 1540~1563nm operating bandwidth for optical amplifier
- Low noise sub number (Typical ≤4.5dB, Max. ≤5.0dB)
- High performance, high reliability
- Polarization Dependent Gain: Max. 0.4dBm
- Polarization Mode Dispersion: Max. 0.5ps
- Input and output pump leakage: -35dBm and -45dBm
- 1550nm output optical port, multiplex 1310/1490nm data stream
- Can be compatible with any FTx PON Technology: EPON/GEAPON, GPON, BPON, DPON
- Perfect RS232, SNMP
- Efficient space, flexible installation and easy operation
- Excellent P/P ratio

Splitter

Passive Optical Splitter

The optical splitter is a passive optical plug-and-play device, which connects OLT and ONUs with multiple fiber ends. A splitter is generally deployed in an optical distribution network, allowing carriers to split optical signals to numerous customer premises. Raisecom provides various optical splitters with the following split ratios: 1:2, 1:4, 1:8, 1:16, 1:32, 1:64 to 1:128. The series is classified as indoor, indoor/outdoor and outdoor optical splitters.



Chapter 6. SME Router

The expansion of small and medium enterprise user groups requires special types of services which are different from those of the residential users and large enterprises. The Raisecom MSG series solution consists of cost effective routers/gateways that offer manageability, high bandwidth, and a secure connection among employees working in a small office using a large number of network devices.

The wireless connectivity enables employees to access all the required business applications while at their desks or in meeting rooms. It also provides complete IP telephony to be delivered in data network. The Raisecom MSG series allows the customer to extend highly secure network connectivity to guests in a variety of locations, such as a hotel, an office lounge, or any other area open to non-employee users. Using powerful, but easy-to-configure security and traffic segmentation capabilities, vital business traffic is isolated from guest services and keeps guests' network sessions totally separate from each other.

High Security Data Access for SME

MSG2110-SHDSL

With the symmetrical data transmission of up to 15 Mbps over the 2-wire line, the G.SHDSL.bis satisfies the needs of multiple users, who require both bandwidth and permanent data connections. MSG2110 is a router with G.SHDSL uplinks. It is cost-effective and extends multiple Ethernet services on the existing copper lines. It may act as the gateway of a small and medium enterprise to connect to the Internet with a wide range of IP and security functions. The flexible QoS configuration enables SME customers to define different flows, such as, VoIP, video and data with a guaranteed or maximum bandwidth allocation. This device is typically deployed as a demarcation point between the carriers and customers and saves the SME customers the cost of buying additional small routers for their security and routing requirements. If the EPL and EVPL are required for a much larger organizations and branches, it can also deliver a Layer 2 carrier Ethernet service for point-to-point access.



MSG2110-SHDSL-2W/4W/8W

FEATURES

- static/dynamic routing (RIP) as well as OSPF
- IPSec, SSL and L2TP VPN, Content filtering
- Anti-DoS, Anti-ARP function
- NAT/NAPT, DHCP and DNS/DDNS
- VLAN, QoS and SLA
- IEEE802.3ah, 802.1ag and ITU-T Y.1731/SLA
- TR069, CLI, Telnet, Web management and SNMP (NView compatible)

Data and VoIP for SOHO/Home

MSG1200-GEC

The Raisecom MSG1200-GEC provides solutions which satisfies the demands of SOHO and Home users. The device offers flexible uplink options including GbE combo ports, and is ideal for concurrent services with stringent performance requirements, such as routing, bridging, NAT/NAPT, DHCP, VPN, Anti-Dos, Access Control ability, VoIP, Anti-Port scanning and IEEE 802.11b/g/n. In addition, it also offers 1 x USB2.0 interfaces, which can be used for either data storage or 3G/4G USB modems of pre-authorized and verified vendors. Two telephone service lines are provided using VoIP technology with SIP or H.248 signaling protocol. The device features quick responses, rapid networking deployment capabilities, as well as resilient performance and exceptional compatibility with multi-types of services while greatly reducing both equipment and management costs.



MSG1200-GEC

FEATURES

- Available with combo GE port at WAN side: 1 x 10/100/1000M Base-T and 1 x 100/1000M Base-X GbE optical port for additional SFP
- Available with 1 x 10/100/1000M Base-T and 3 x 10/100M Base-T at LAN side
- Available with 2 FXS ports at LAN side
- Available with 1 x USB interface on the front panel
- Static/dynamic routing (RIP) as well as OSPF
- IPSec, SSL and L2TP VPN, Content filtering
- Anti-DoS, Anti-ARP function
- NAT/NAPT, DHCP and DNS/DDNS
- VLAN, QoS and SLA
- RFC 3015, 3425, ITU-T H.248.v1/v2/v3
- Voice CODECs like G.711, G.726, G.729AB, BV16, ILBC, T.38, etc.
- RTP / RTCP: RFC 3550, RFC 3551
- IEEE 802.11b/g/n connections
- TR069, CLI, Telnet, Web management and SNMP (NView compatible)

Integrated Access Devices

MSG310 / MSG320

Raisecom MSG300 series, including MSG310 series (plastic shell) and MSG320 (metallic shell), mainly providing Voice over IP (VoIP) or Fax over IP (FoIP) services. As the new-generation small-capacity Integrated Access Devices (IADs), they can provide low-density commercial buildings or small enterprises with integrated access services of voice and data. The MSG300 series can provide 4, 8, 16, 24, or 32 voice interfaces, as required by the number and density of users.



MSG310-4V



MSG320-4V



MSG320-GEC-32V-AC

FEATURES

- VoIP (SIP, H.248)
- Support Telephone, Fax, POS
- Supplementary services such as call hold, call waiting, call forwarding, three-way calling, etc. (work with Core Network)
- Bridging, Layer 2 Switching
- VLAN Tagging (802.1Q), Priority with QoS (802.1P)

P/N	MSG310-4V/8V	MSG320-4V/8V	MSG320-16V/24V/32V
Voice interface	4/8 FXS voice interfaces (RJ11)		16 FXS voice interfaces (RJ11) or 2 SCSI50 interfaces
Dimension	198 mm × 163 mm × 35mm (plastic shell)	260 mm x 130 mm x 43.6 mm (metallic shell)	440 × 220 × 43.6 (metallic shell)
WAN side	1 GE interface	One GE electrical interface or one 1000 Mbit/s Combo interface	
LAN side	2 FE interfaces	3 FE + 1 GE interfaces	

Chapter 7. Industrial Switch

As the Ethernet technologies mature, Industrial Ethernet products and solutions are gaining popularity in the vertical industrial, utility, transportation and public marketplaces for their core values of enhanced manageability, network redundancy, scalable bandwidth up to GE and 10G, and comprehensive performance monitoring. In addition, the managed Ethernet technologies, which are introduced into industrial applications assist with the integration of many systems over an expandable network across wired and wireless LANs and WANs.

The Raisecom Gazelle series is designed to meet strict industrial demands of mission-critical applications, such as the smart grid industry, traffic control and surveillance systems. The carefully selected L2 Gigabit and Fast Ethernet models support advanced QoS, enhanced network security, resiliency and reliability, and are applicable for a wide range of industry and business connections under tough conditions. In compliance with IEC 61580-3 and IEEE 1613, the series guarantees the highest standards of EMI immunity and error-free communication, which is generally required for intelligent power plants, substations, transmission lines and ammeter readings. Reinforced hardware design, 50ms ring protection and power redundancy further increase network reliability and greatly reduce the cabling and wiring complexity.

L2 DIN-Rail Manageable Industrial Switch

Gazelle S1010i/S1020i/S1112i-PWR/S1003i/S1006i/S1508i/ S1508i-PWR/S1503i

The Gazelle S10xxi series consists of cost-effective, compact and manageable industrial switches with a wide selection of port numbers, speed and media types. These access switches enable delivery of reliable, continuous, and manageable services by complying with several industrial regulations and standards. Network and power redundancy are also included to ensure maximum uptime. Ethernet redundant rings can be supported at any interface with a recovery time of sub-50ms. In addition, the Gazelle S1112i-PWR supports the POE function with at least 4 IEEE802.3at ports or 8 IEEE802.3af ports. The Gazelle S1508i-PWR supports POE function with 4 IEEE802.3at ports or 4 IEEE802.3af ports. Products in this Gazelle series use IP40 housing and fanless design with a wide operating temperature ranging from - 40 to 85°C. This switch supports DIN rail, wall mounting and rack mounting. The Gazelle S1508i is a Full-Gigabit Layer 2 Din-Rail manageable industrial switch that is designed to satisfy the requirements of data transmission in areas of smart grid (IEC 61850-3, IEEE 1613), transportation (EN50121-4), energy and industrial automation. The design enables maximum flexibility among electrical, SFP and GE combo interfaces. It supports up to 4GE uplinks and 4GE downlinks. Network redundancy and reliability are guaranteed with LACP, G.8032 ERPS (<50ms switch-over time).



Gazelle S1010i



Gazelle S1020i



Gazelle S1003i



Gazelle S1503i



Gazelle S1006i



Gazelle S1508i



Gazelle S1112i-PWR



Gazelle S1508i-PWR

P/N	Gazelle S1010i	Gazelle S1020i	Gazelle S1112i-PWR	Gazelle S1006i	Gazelle S1003i	Gazelle S1508i	Gazelle S1508i-PWR	Gazelle S1503i
100/1000M Base-X SFP ports	3 ports	4 ports		N/A		2 ports		1 port
10/100/1000M Base-TX ports	N/A			N/A		4 ports		2 ports
100M Base-FX ports(1x9,ST,SC or SFP based)	N/A			2 ports	1 port	N/A		
10/100M Base-TX ports	7 ports	16 ports	8 ports	4 ports	2 ports	N/A		
GE Combo ports	N/A			4 ports	1 port	N/A		
POE	N/A	4 x 802.3at or 8 x 802.3af			N/A		4 x 802.3at or 4 x 802.3af	N/A
DHCP	DHCP client, snooping and option82							
Protection	STP/RSTP/MSTP for network redundancy with a switch-over time less than 50ms, LACP 802.3ad							
VLAN, QinQ and QoS	Supported							
OAM	802.3ah							
Multicast	IGMP, MVR							
Temp Range	- 40 to 85°C							
IP Level	IP40							
Installation	DIN-Rail, wall-mount, rack-mount							
Management	Serial Line Control, CLI, Telnet, SSHv2, Web Management and SNMP (NView compatible)							
MTBF	>35 Years							
Certification	IEC61850-3 and IEEE1613 compliant for Smart Grid EN50121-4 compliant for traffic transportation							

L2/L3 19" Full Gigabit Manageable Industrial Switch

Gazelle S5028i/S6028i/S6052i

The Gazelle S5028i/S6028i/S6052i are full-gigabit L2/L3 rack-mounted manageable industrial switches, designed to satisfy the broadband backbone transportation and aggregation requirements under rigorous industrial and business conditions. The products employ a full modular design and supports a flexible electrical and SFP optical interface with combinations of up to 4 x 10GE/GE uplinks and 48 x GE downlinks. The S5028i/S6028i/S6052i enable maximum flexibility when configured, in rings (intersect ring and tangent ring topologies), ensuring sub-50ms switchover time. Enhanced security is provided by supporting IEEE802.1x, RADIUS and other authentication methods. The Gazelle S5028i/S6028i/S6052i can sustain high performance in extreme environments and operates normally over a wide temperature range from -40 to 85°C. It also claims a fanless design, as well as IP40 dust protection housing, a redundant power supply, and is compliant with IEC 61850-3, IEEE 1613 and EN50121-4.



Gazelle S2028i/S3028i/S5028i/S6028i



Gazelle S6052i

Features/Device List	Gazelle S2028i	Gazelle S3028i	Gazelle S5028i	Gazelle S6028i	Gazelle S6052i
Uplink Slots	2 x GE uplink slots of 2 x 10/100/1000M Base-TX or 2 x GE SFP ports	2 x GE uplink slots of 2 x 10/100/1000M Base-TX or 2 x GE SFP ports	2 x GE uplink slots of 2 x 10/100/1000M Base-TX or 2 x 10GE/GE SFP ports	2 x GE uplink slots of 2 x 10/100/1000M Base-TX or 2 x 10GE/GE SFP ports	4 x 10GE/GE SFP ports
Downlink Slots	6 x FE downlink slots of 4 x 10/100M Base-TX or 4 x FE SFP ports	6 x FE downlink slots of 4 x 10/100M Base-TX or 4 x FE SFP ports	6 x GE downlink slots of 4 x 10/100/1000M Base-TX or 4 x GE SFP ports	6 x GE downlink slots of 4 x 10/100/1000M Base-TX or 4 x GE SFP ports	24 x 10/100/1000M Base-TX ports, 6 x GE downlink slots of 4 x 10/100/1000M Base-TX or 4 x GE SFP ports
Routing	N/A	Static routing, RIP, OSPF, VRRP	N/A	Static routing, RIP, OSPF, VRRP	
VLAN, QinQ and QoS	Supported				
Protection	ISTP/RSTP/MSTP and G.8032 for network redundancy with a switch-over time less than 50ms, LACP 802.3ad				
Multicast	IGMP, MVR				
DHCP	DHCP client, snooping and option82				
OAM	IEEE802.3ah				
Temp Range	-40°C to 85°C				
IP Level	IP40				
Installation	Rack-mount				
Management	Serial control platform, CLI, Telnet, Web management, and SNMP (NView compatible)				
MTBF	>35 Years				
Certification	IEC61850-3 and IEEE1613 compliant				

L2 Manageable EN50155 Industrial Switch

Gazelle S1210i/S1218i-PWR

The Gazelle S1210i is an L2 DIN rail manageable EN50155 industrial switch designed to satisfy the requirements of data transmission specifically in the field of railway transportation. Gazelle S1210i supports up to 2 GE uplinks and 8/16/24 FE downlinks with an M12 connector. Gazelle S1218i-PWR supports up to 2 GE uplinks and up to 6 GE downlinks with an M12 connector. The Gazelle S1218i-PWR supports PoE function with 2 IEEE802.3at ports or 4 IEEE802.3af ports. Gazelle S1210i/1218i-PWR has a fanless design with an IP67 protection and a redundant power supply. The network redundancy and reliability are guaranteed with LACP, G.8032 ERPS (sub-30ms switchover time), and a 24VDC power supply.



Gazelle S1210i



Gazelle S1218i-PWR

FEATURES

- Available with 2 x 100/1000M Base-FX optical ports and 8/16/24 x 10/100M Base-TX electrical ports
- Wide operating temperature range: -40 to 85°C
- IP67 protection level
- Rugged DIN -rail design
- DHCP client, snooping and option82
- STP/RSTP/MSTP and G.8032 for network redundancy with sub-30ms switch-over time
- VLAN, QinQ and QoS
- IEEE802.3ah OAM
- IGMP and MVR for multicast traffic
- IEEE802.3ad LACP for optimum bandwidth utilization
- CLI, Telnet and SNMP (NView compatible)
- IEC61850-3 and IEEE1613 for smart grid applications
- EN50155 compliant for transportation applications
- DIN rail, wall mounting and rack mounting installation
- MTBF >35 Years

DIN Rail 3G/4G Router

Gazelle R101i/R102i/R202i/R202i-VM/R204i

The Raisecom Gazelle R101i/R102i/R202i/R202i-VM/R204i series provides solutions that satisfy the requirements for SME and outdoor networking deployment scenarios, such as financial industry, environmental protection, transportation, postal industry, monitoring, military, meteorology, utility and residential areas.

The Gazelle R102i/R202i/R202i-VM/R204i allows up to 6 Ethernet-based devices to simultaneously use a single cellular data account for primary or backup network connectivity to remote sites and devices. By integrating routers, switches, firewalls, VPN, and 3G/4G in a single device, the Gazelle series provides the high performance, which is essential for concurrent services. These services include firewall, content filtering, encryption for VPNs, cellular data for mobility, data storage with USB 2.0, and quality-of-service (QoS) features for optimizing voice and video applications at broadband speeds. The use of this device significantly reduces both equipment and management costs.



Gazelle R102i



Gazelle R202i



Gazelle R101i



Gazelle R202i-VM



Gazelle R204i

Features/Device List	Gazelle R101i	Gazelle R102i	Gazelle R202i	Gazelle R202i-VM	Gazelle R204i
10/100/1000M Base-TX ports	N/A		2 ports	1 port	6 ports (2 x SFP+4 x RJ45)
10/100M Base-TX ports	1 ports	4 ports	N/A	4 ports	N/A
3G Uplink	WCDMA/CDMA2000 compatible				WCDMA/CDMA2000 compatible
4G Uplink	N/A		FDD/TD-LTE compatible	FDD/TD-LTE compatible (dual 4G modules)	FDD/TD-LTE compatible (dual SIM cards)
Serial Interfaces	RS-232/485 serial interface (reuse)	RS232/485/422 (DB9)		N/A	RS232+RS485 (PIN)
USB2.0	N/A		Supported	N/A	
Wi-Fi	802.11b/g/n	N/A	802.11b/g/n		
Security	IPSec, L2TP GRE VPN, Anti-DoS, Anti-ARP, Anti-Scanning				
Routing	N/A	Static routing, RIP, OSPF			
Function	NAT NAT/PAT, DHCP and DNS/DDNS	IGMP Proxy/Snooping, PPPoE, NAT NAT/PAT, DHCP and DNS/DDNS, DMZ function			
Temp Range	-20°C to 70°C		-25°C to 70°C		
IP Level	IP40				
Installation	DIN-Rail, wall-mount	DIN-Rail, wall-mount, rack-mount			
Management	Telnet, Web management and SNMP (NView compatible)	Serial control platform, CLI, Telnet, Web management and SNMP (NView compatible)			
MTBF	>35 Years				
Certification	IEC61000 compliant		IEC61850-3 and IEEE1613 compliant		

Chapter 8. PCM for SCADA

The Raisecom PCM for SCADA has been designed especially for utility, industry, transportation and military application projects where special requirements must be fulfilled for mission-critical data and voice traffic. In addition, PCM helps users benefit significantly from maximum network extendibility over existing network infrastructures. The central platform RC3000-15/6, also known as the Multi-Service chassis, delivers and integrates narrowband and broadband services transmitted by the RC3000E at the remote side. The modular design of RC3000E chassis allows providers to benefit from maximum flexibility to achieve specific requirements and goals, while keeping their Total Cost of Ownership (TCO) under control. The Raisecom SCADA solution is known for its robustness and reliability in access networks. This solution gained and is gaining its popularity in the following industries: power grid, water and natural gas, oil, mining and national security, public health and transportation.

Multi-Service Chassis

RC3000-15

The Raisecom RC3000-15 is an intelligent multi-service access platform and is mainly applicable in dedicated networks, Utilities and Transportation transport networks. The device is a Digital Access and Cross-connect System (DACs), which integrates the following functions: digital/analog access, cross-connection and transmission. RC3000-15 is compatible with the Multi-Service Terminal Mux and can be synthesized under the Raisecom NView system for real-time configuration, management, monitoring and trapping.



RC3000-15

FEATURES

- Available with 4 x STM-1 and 2 x GE at line side; 7U chassis with 15 slots
- Non-blocking cross-connect of up to 4096 DS0 channels
- EOS
- 1+1 protection over STM-1 optical interface
- Available with sub-cards supporting electrical/optical E1, FE, FXS, FXO, 2/4W E&M, magneto, hotline, dry contact, co-directional 64K, V.35, V.24, RS232, RS422, RS485 at client side
- Configurable E1 interface gain mode to expand transmission distance
- A software configurable attenuation of each TX/RX channel with increments of 0.1dB for voice modules
- Link Capacity Adjustment Scheme (LCAS) for inverse multiplex modules
- DXC module supports alarm input and output, external clock supports 2Mbps and 2MHz
- All sub-cards hot-swappable
- 1+1 protection over E1 and PSU/DXC cards
- Power supply and fan modules with monitor
- Auto Laser Shutdown (ALS) and Build-in BERT
- Inside and outside loopback for individual tributary cards
- VCC channel for remote network management
- SNMP (NView compatible) via in-band and out-of-band network channels

P/N	RC3000-15
Size/slot	7U/15-slot
Cross connect	512 Mbps
STM-1 interface	4
E1 channel	88
FXS/FXO channel	352
E&M channel	176
V.35 channel	88
V.24 channel	88
RS232 channel	176
FE port	88
Magnet interface	120

System and Sub-cards

- RC3000-15-A, 7U/15-slot chassis with ventilation modules only
- RC3000-15-DXC, system management & Control Card
- SUB-BITS-CLK, insert on the DXC card to provide 2Mbit and 2MHz external clock function
- RC3000-15-STM1, SDH aggregated unit with two STM-1 optical interfaces with SFP connector, 4 FE interfaces and 4 E1 unbalanced or balanced interfaces with DB37 connector
- RC3000-15-8E1, E1 tributary unit with 8E1 unbalanced or balanced interfaces, support one-plus-one port/card protection
- RC3000-15-P240-4FE-OPT-S1, PDH tributary unit with dual optical interfaces for redundancy and 4 FE interfaces and 8 E1s transmission capacity
- RC3000-15-32FXS, 2-wire Foreign Exchange Subscriber (FXS) interface card, 32 interfaces per card, DB37 connector
- RC3000-15-32FXO, 2-wire Foreign Exchange Office (FXO) interface card, 32 interfaces per card, DB37 connector
- RC3000-15-8S8O, 2-wire FXS and FXO interface card, 8-channel FXS and 8-channel FXO interfaces per card, DB37 connector
- RC3000-15-16E&M, 2/4 wire E&M interface card, 16 interfaces per card, HDB26 connector
- RC3000-15-8ETHP, High speed Ethernet interface card, which provides 8 channels 10/100 Base-T Ethernet port, data rate: N×64Kbps (N=1~31)
- RC3000-15-8RS232H, low speed RS232 data interface card with handshaking, up to 57.6Kbps RS232, 8 interfaces per card with RJ45 connector
- RC3000-15-8RS485, low speed RS485/RS422 data interface card, up to 38.4Kbps RS485/RS422 data, 8 interfaces per card with RJ45 connector
- RC3000-15-8V35, high speed V.35 synchronous data interface card, 8 interfaces per card, user selectable data rate N × 64Kbps of "N" (1~31)
- RC3000-15-8V24H, low speed V.24 data interface card with handshaking, up to 128Kbps V.24 synchronous data 8 interfaces per card
- RC3000-15-16C64K, G.703 Co-directional of 64Kbps data interface card, 16 interfaces per card, RJ45 connector
- RC3000-15-TP, Teleprotection card, support 4 ST optical interfaces and optical interface 1+1 protection, and support capacity compression. Services of each interface only occupy "1+N" (N = 1~12) 64 Kbit/s timeslots at the line side when they are multiplexed

Multi-Service Terminal Mux

RC3000E

RC3000E is a standalone multi-service terminal mux that uses E1 circuit resources in order to provide digital and analog accesses, multiplexing, voice and data cross-connections and transmissions. The product can be deployed in a variety of network topologies, such as point-to-point, chain, star and mesh. The 1U compact device also utilizes a wide range of interfaces for narrowband and broadband access.



RC3000E

FEATURES

- Available with 1 uplink slot and 3 downlink slots
- Supports non-blocking cross-connect of up to 512 DS0 channels
- Available with uplink card 4/8 channels electrical E1 or optical E1+FE interface
- Available with sub-cards supporting FXS/FXO, E&M, V.24, RS232, RS422, RS485, V.35, G.703 co-directional 64K and 10/100M Base-T Ethernet at the client side
- 1+1 protection over electrical E1 interfaces and PSU cards
- Hot-swappable for all sub-cards
- Built-in BERT
- Remote configuration control and performance monitoring
- Software configuration alarm output function
- CLI, Telnet and SNMP (NView compatible)

Chapter 9. Ethernet over Everything

Beyond the Metro network, the Ethernet services are not limited to cities or national borders and can extend to multiple providers globally. To support services crossing multiple providers and borders, wholesale demarcation must be implemented, in order to perform performance monitoring, guarantee SLAs and deliver end-to-end QoS. Wholesale demarcation enables service performance visibility between wholesale terminals and service providers. Raisecom supports Ethernet demarcation over PDH/SDH as well as G.SDHSL. . Raisecom access devices enable service providers to benefit from full OAM capabilities, effectively deploying and supporting new services and a managed SLA commitment.

Working in tandem with tier-1 carriers, Raisecom has developed a full set of Carrier Ethernet access solutions that can be used over existing network infrastructures, such as traditional TDM networks, dark fiber and twisted pairs.

Ethernet over Fiber

RC552-FE, RC552-GE

RC552-FE and RC552-GE are carrier-grade media converters designed for business access. The series offers advanced 802.3ah OAM features and redundancy, as well as high reliability enabled by 1:1 dual-homing uplink protection at both port and system levels. The series can be deployed in both point-to-point and point-to-multipoint topologies. Installed in the Raisecom RC002 chassis, the device can be managed by the Raisecom NView NNM system via the SNMP agent. It also supports a web management that simplifies remote troubleshooting and maintenance.



RC552-FE



RC552-GE

P/N	RC552-FE	RC552-GE
Client side	1 x 10/100M Base-T	1 x 10/100/1000M Base-T
Line side	2 x 100M Base-FX SFP	2 x 1000M Base-X SFP
Protection	1:1 uplink protection	
VLAN, QinQ	Supported	
OAM	802.3ah	
Rate limit	Supported	
Fault pass through	Fault pass through	
Certification	MEF9, 14	
Management	Web Management and SNMP (Nview compatible)	

Ethernet over PDH

RC959-GESTM1, RC959-4FE16E1, RC953-4FExE1T1, RC951E-4FEE1

The RC959 series offers a standard GFP-encapsulation EoPDH aggregation used for delivering segregated Ethernet services over existing legacy networks. It meets customer requirements in terms of advanced Ethernet switching and diagnostics containing full L2 switching functionality and standard Ethernet OAM/CFM features. The flexible RC959-4FE16E1(-BL) can act both as an aggregator and/or a remote demarcation in point-to-point and point-to-multipoint topologies. The RC959-GESTM1 is only deployed at the POP site operated by service providers and is used for aggregating services from remote demarcation, such as the RC951E-4FEE1, RC953-4FExE1T1 series and RC959-4FE16E1(-BL). Both models allow carriers to offer flexible service channels from 2Mbps to 32Mbps with protection enabled by LCAS from unexpected E1 link failures. As Ethernet Demarcation Devices (EDD) with 4 x FE at the client side, the RC951E-4FEE1 and RC953-4FExE1T1 can support up to 1 x E1 and 4/8 x E1 respectively. In addition, this series offers advanced OAM and network diagnostic features in addition to L2 switch functionality. The RC95x series can be deployed in point-to-point scenarios, as well as working with non-Raisecom aggregation gateway, building a customized Ethernet service channel over existing PDH/SDH networks owned by Carriers. Standardized GFP encapsulations assure outstanding interoperability and a broader field of applications.



P/N	RC959-GESTM1	RC959-4FE16E1	RC953-4FExE1T1	RC951E-4FEE1
Client side	2 x STM1	16 x E1	4/8 x E1	1 x E1
Line side	2 x GE	4 x FE and 1 x GE	4 x FE	4 x FE
Encapsulation	GFP		GFP/HDLC	
VLAN, QinQ, QoS	VLAN, QinQ, QoS, Ingress rate limit, Egress traffic shaping			
OAM	802.3ah, 802.1ag, Y.1731/SLA			
Resiliency	VCAT, LCAS, error status monitoring, link diagnostic			
Management	Serial Line Control, CLI, Telnet and SNMP (NView compatible)			

Ethernet over Copper (SHDSL.bis)

RC1108-SHDSL-2Wx8, RC1104

The RC1108 is a SHDSL.bis aggregation module compatible with the iTN2100, OPCOM3500E and RC3000-15 chassis. By supporting TC-PAM128 technology, it can deliver symmetrical data of up to 15Mbps per 2-wire. This module allows for the transmission of E1 and FE services over STM1/4 or Metro Ethernet through copper cables, and fulfills the need for both bandwidth and permanent data connections. The RC1104 series are SHDSL CPEs, which can extend the transmission of E1 and/or Ethernet services over 4-wire copper, enabling service providers to deliver cost-effective broadband access and leased-line services. Powered by TC-PAM128 technology and EFM-bonding, symmetrical data services can be offered at the rate of up to 15Mbps per pair of wires, enabling a maximum transmission distance of 2.6km (under lab conditions) through 0.4mm 2-wire copper cable. The RC1104 is mainly used to extend Ethernet or E1 service cost effectively, and is perfect for fast deployment of massive units. RC1104 devices can work in pairs or can be aggregated by the RC1108. By employing the integrated Raisecom NView system, carriers can effectively configure parameters and monitor performance using the graphic user interface (GUI) integrated in all the devices.



P/N	RC1108-SHDSL-2Wx8	RC1104
Client side	1 x GE	1 x FE/E1/V.35
Line side	8/16-wire SHDSL	2/4-wire SHDSL
VLAN, QinQ, QoS	Supported	N/A
OAM, SLA	802.1ag, 802.3ah, Y.1731, SLA	N/A
E1 mode	Framed/unframed	
Bonding	EFM bonding	
Resiliency	Fault pass through, flow control, storm control	
Management	CLI, Telnet and SNMP (NView compatible)	

Chapter 10. Multi-Service Last Mile Access

The Raisecom multi-service last mile access product line offers flexibility and robustness for diverse data and voice applications at a low cost, with minimum deployment effort and optimized administration, management and operation. The product line includes the best-selling mini-SDH, interface converter, fiber optical modem, FiberMux and multi-service modem pool and chassis.

SDH ADM

OPCOM3107-16E1-BL

The OPCOM3107 is a compact, cost-effectiveness and versatile device ideally suited for voice and data transmission. It provides services ranging from traditional E1 to Fast Ethernet. The OPCOM3107 supports 16 fixed E1 ports, 4 Fast Ethernet ports and 1 GE combo port. It also provides one alarm terminal and a 2Mbit/2MHz external clock connector. For Ethernet over SDH services, the OPCOM3107 uses a standard Generic Framing Protocol (GFP) mapping, Link Access Procedure SDH (LAPS) Virtual Concatenation and Link Capacity Adjustment Schemes (LCAS) for dynamic bandwidth allocation. All these features enable the OPCOM3107 to be considered the next-generation STM-1 access device.



OPCOM3107-16E1-BL

FEATURES

- Available with 2 x STM-1 & 16 x E1 interfaces in balanced mode, 4 x RJ45 Fast Ethernet and 1 x combo GE interface
- Available with 2Mbit/2MHz external clock and 1 alarm input and output interface
- Popular as a NG access device playing aggregation, add-and-drop multiplexer (ADM) and/or Terminal multiplexer (TM) roles in STM-1 ring or daisy chain topology
- Hybrid cross-connection between VC3 and VC12
- GFP/LAPS encapsulation, VCAT and LCAS function
- VLAN, QinQ, QOS, ACL, rate limit, mirror and storm control
- 1+1 MSP, one-plus-one LPP and redundant power supply
- Retiming on the 1st to 4th E1 channels
- ALS, LPR
- Local/remote online upgrade and management
- CLI and SNMP (NView compatible) via in-band and out-of-band network channels

Fiber Optical Transmission Device

RC802-DS3/E3

The RC802-DS3/E3 is an optical fiber transmission device designed to transmit DS3 or E3 services over fiber. It contains one SFP optical port for uplink and one BNC interface for downlink that can be configured to DS3 or E3, using the DIP-switch. This modular device operates in the Raisecom RC001/002 series chassis where it can be locally managed using the SNMP agent and can be remotely managed when working in conjunction with the iTN2100 on the Raisecom NView NNM system.



RC802-DS3/E3

FEATURES

- DDMI for SFP fiber uplink
- Local/remote loopback on the fiber port and local loopback on a DS3/E3 port
- In-built bit error tester to assist fault location
- ALS on a fiber port
- Remote power-off alarm in point-to-point topology
- Local SNMP management in RC001/002 series chassis and remote SNMP management when working in conjunction with iTN2100

Fiber Optical Modem

RC862-30-BL, RC862-30-FV35

The RC862-30 series is designed to transmit an E1 or V.35 service over fiber optic. The RC862-30-BL provides one fiber optic uplink and one E1 link on the customer side, while the RC862-30-FV35 provides one fiber optic uplink and one V.35 interface on the customer side. The devices are usually deployed in point-to-point topology, RC862-30-BL with RC862-30-BL, RC862-30-BL with RC862-30-FV35, or RC862-30-FV35 with RC862-30-FV35. These modules operate in the RC001/002 series chassis, and can be locally and remotely managed via the GUI of the Raisecom NView NNM system.



RC862-30-BL



RC862-30-FV35

P/N	RC862-30-BL	RC862-30-FV35
Client side	1 x E1	1 x V.35
Line side	1 x optical interface	
E1 mode	Framed/unframed	
Loopback	Local/remote	
Clock	Master/slave	Master/slave/V.35 terminal clock
Alarm	Remote power off alarm	
Inner bit error tester	Supported	
Management	CLI, Telnet and SNMP (NView compatible)	

Multi-Service Fiber Mux

RCMS2902-60FE-BL, RCMS2912-4(8)E1T1GE, RCMS2903-4E1-4GE, RCMS2911-16E1-4GE-BL

The RCMS2900 series is a multi-service Fiber Mux, designed mainly for scenarios of small or medium enterprise access and 2G/3G mobile backhaul. The RCMS2902-60FE-BL and RCMS2912-4(8)E1T1GE are modular devices that can work in RC001/2 series chassis supporting both local and remote management via NMS. The RCMS2903-4E1-4GE and RCMS2911-16E1-4GE-BL are standalone, multi-service Fiber Mux. The latter can support up to 16E1, as well as offer one-plus-one protection redundancy for uplinks. The RCMS 2900 series is typically used for point-to-point scenarios, or aggregated by an iTN2100 multi-service access platform.



RCMS2902-60FE-BL



RCMS2912-4(8)E1T1GE



RCMS2903-4E1-4GE



RCMS2911-16E1-4GE-BL

P/N	RCMS2902-60FE-BL	RCMS2912-4(8)E1T1GE	RCMS2903-4E1-4GE	RCMS2911-16E1-4GE-BL
Client side	2 x E1+1 x FE	4/8 x E1/T1 + GE	4 x E1 + 4 x GE	16E1 + 4 x GE
Line side	1 x F.O. interface	2 x F.O. interfaces (1+1 protection)	1 x F.O. interface	2 x F.O. interfaces (1+1 protection)
Loopback	Local/remote loopback			
MTU	1,916 Bytes	9,728 bytes	9,720 bytes	9,600 Bytes
VLAN, QinQ, QoS	N/A		Supported	
Switching mode	N/A		Supported	
Rate limit	Supported			
Flow control	Supported			
Alarm	Remote power off alarm			
Inner bit error tester	Supported			
Fault pass through	Supported			
Management	CLI, Telnet and SNMP (NView compatible)		Serial Line Control, CLI, Telnet and SNMP (NView compatible)	

Multi-Service Modem Chassis

RC002-16

The RC002-16 is a 19" 3U height rack-mountable chassis, in which up to 16 service modules can be installed. It provides a CO/POP site solution for connecting up to 16 remote customers. The chassis is SNMP manageable with an SNMP agent module, which takes up one of the sixteen slots. Each service module in the RC002-16 operates in a point-to-point topology with a remote unit. The two devices work independently and do not influence the operation and management of the other modules in the same chassis. All modules, including the SNMP agent module, are hot-swappable. One AC or DC power supply module is able to support a full chassis of service modules regardless of service types. The RC002-16 can use two power supply modules to provide a redundant and flexible power supply solution for the customers. When working with the SNMP agent module RC002-NMS1, all the service modules in the RC002-16 can be network managed on the GUI of the Raisecom NView NNM system.



RC002-16

FEATURES

- Rack-mountable 3U chassis for housing and network management of up to 15 service cards
- 16 slots of plug-in cards including RC002-NMS1/RC001-NMS2 as SNMP agent
- Flexible and redundant power supply modules
- Cascade up to 4 chassis with maximum management capacity of 60 pairs of service cards
- Rack-mountable 3U chassis for housing and network management of up to 15 service cards
- 16 slots of plug-in cards including RC002-NMS1/RC001-NMS2 as SNMP agent
- Flexible and redundant power supply modules
- Cascade of up to 4 chassis with maximum management capacity of 60 pairs of service cards

Single/Double-Slot Chassis

RC001-1, RC001-1M, RC001-1D, RC001-2D, RC001-2M

RC001 single and double slots chassis series is designed for telecom carrier and important enterprise users in the fields of finance, electric power, oil and gas industries. When fixed into a RC001 chassis, the modular media converters, fiber modem, multi-service fiber mux, interface converters, CWDM, G.SHDSL modems and other modules, which are all designed for 1U slot, become stand-alone and network-manageable equipment.

The built-in SNMP agent module of the RC001 provides network management function, such as configuration management, diagnostics, and loop activation, monitoring and fault management. The RC001 has one console port, one Ethernet port and 1/2 slot for modular device on the front panel. The AC and DC power supply connectors on the rear panel of the chassis provide users with the flexibility of using an AC power supply, a DC power supply, or both.



RC001-1D



RC001-1

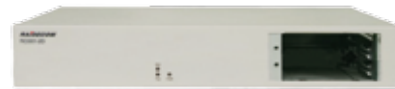

RC001-2D



RC001-2M



RC001-1M

P/N	RC001-1	RC001-1M	RC001-1D	RC001-2D	RC001-2M
Size/Slot	1U/1-slot	1U/1-slot	2U/1-slot	2U/2-slot or 2U/1-slot	
Power supply	AC/DC/WP	Single/dual AC Single/dual DC Single/dual WP, AC+DC	AC/DC/WP	Single/dual AC Single/dual DC Single/dual WP, AC + DC	
Power protection	Overcurrent/short circuit protection	Overcurrent/short circuit/overheat protection	Overcurrent/short circuit protection	Overcurrent/short circuit/overheat protection	
Management	Remote CLI, Telnet and SNMP (NView compatible)	Serial Line Control, Local/remote CLI, Telnet and SNMP (NView compatible)	Remote CLI, Telnet and SNMP (NView compatible)		Serial Line Control, Local/remote CLI, Telnet and SNMP (NView compatible)

Chapter 11. Network Management System

The ultimate goal of developing a network management system is to maximize the network efficiency and minimize. The Raisecom Network Management System NView NNM covers the two lowest layers of the TMN architecture. With a design is based on the FCAPS model, this software includes fault, configuration, performance and security management functions. A northbound interface is also available on the system for the integration of network management systems, implementing full FCAPS functions on the last three levels of the TMN architecture.

The Raisecom NView NNM system is a Client/Server structured system, in which several clients can work with one server to ensure efficient device monitoring and managing. All Raisecom network manageable products include built-in SNMP agents allowing them to communicate with Element Management Systems (EMS). They also integrate a uniform platform, consisting of topology, inventory, configuration, customer, fault, performance and security management components, to administer all equipment in the network in one topology. Third-party NMSs can directly manage Raisecom network manageable devices by using Raisecom MIBs.

In addition, an upper-level NMS/OSS/BSS can share data and results on the NView NNM system through the northbound interface. The system also provides a disaster recovery solution, protecting the server from fatal disasters and ensuring continuous running of the system by setting up a backup server and keeping it constantly synchronized with the main one.

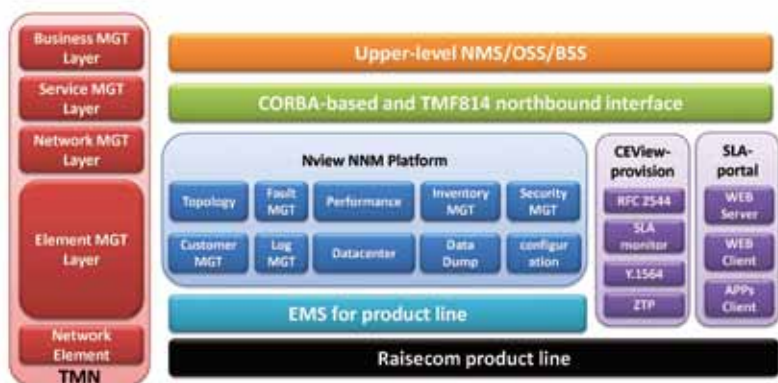
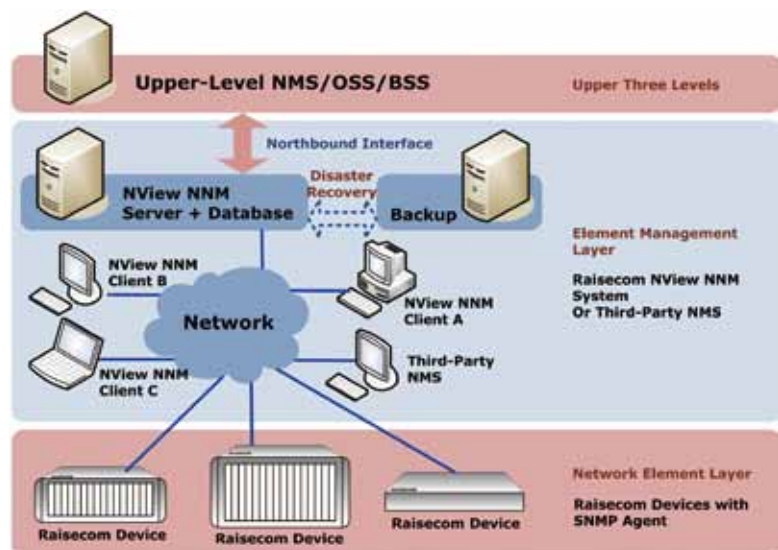

Topology Management

The Raisecom NView NNM system displays all the graphic network elements and links. Dynamic network status indicators and alarms are displayed according to port, card, device, sub-network and network topology, facilitating monitoring and directing the users clearly to the relevant information.

- Multi-level topology displaying
- Manual or automatic topology arrangement
- Device node auto-discovery mechanism
- Device sub-graph auto-drawing mechanism
- Network topology pre-planning mechanism
- Clear indication of current alarm status and



device offline status

- Quick location of point of failure in the network
- Topology style customization

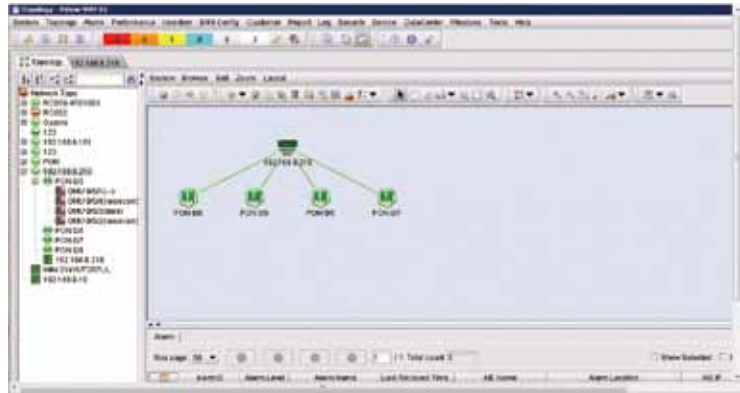

Inventory Management

All resource-related information is displayed from different viewpoints in the inventory management module to assist network operators to manage resources uniformly and to provide a reliable basis for further network expansion.

- Unified management tool for resources, such as devices, chassis, slots, cards, and ports
- Comprehensive resource description, including customer and fault information
- Uniform query platform for rapid search of resources
- Synchronization mechanism that guarantees the system showing real-time status of network resources

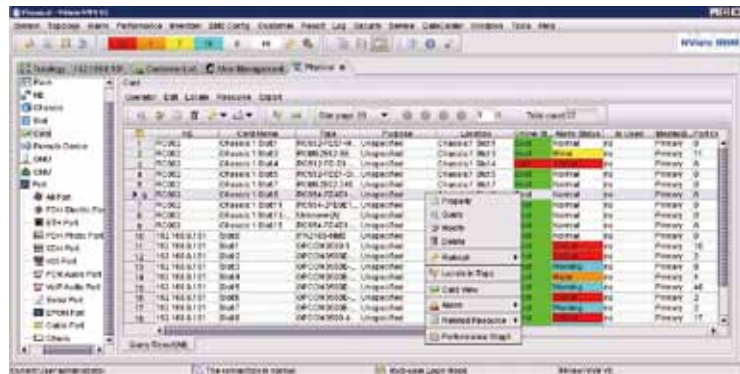

Configuration Management

Configurations can be distributed to devices across the network. Easy management and provisioning is provided by a user-friendly point-and-click GUI with a realistic representation of devices.

- Uniform platform for different EMS systems, different devices share topology, resources, fault, performance, security functions
- User-friendly device status displayed on device panels drawn by EMS
- Real-time status feedback for every device configuration
- Data center provided for centralized management of firmware upgrade and configuration file upload/download
- Batch configuration of SNMP parameters
- Zero configuration mechanism

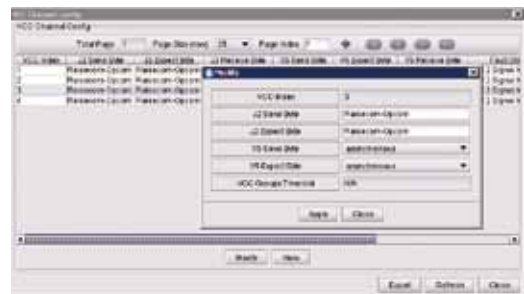

Fault Management

The Raisecom NView NNM system supports advanced fault detection and analysis functions, and realizes real-time monitoring and timely fault reporting. Full-scale alarm management information, such as alarm statistics, alarm location, alarm status, etc. helps the network operator restore devices to their original working configuration when necessary.

- Standard five-level alarm display
- Separate lists for current and historical alarm management
- Grouped alarm monitoring interface, defined according to customer requirements
- Customized alarm filter rules that enable the display of events in order of importance
- Automatic alarm lists clearing service
- Alarm forward service that forwards alarms received on NView NNM to third-party platforms via SNMP
- Alarm locating and troubleshooting library to ensure quick and easy fault removal



Customer Management

The Customer Management module establishes the correlation between devices and customers to ensure efficient handling of information, particularly in the event of abnormal operation, when it is essential to troubleshoot and to quickly establish the problem that will bring about a more rapid solution

- Centralized customer information management
- Customer-based resource management
- Customer-based fault management
- Import and export of customer information

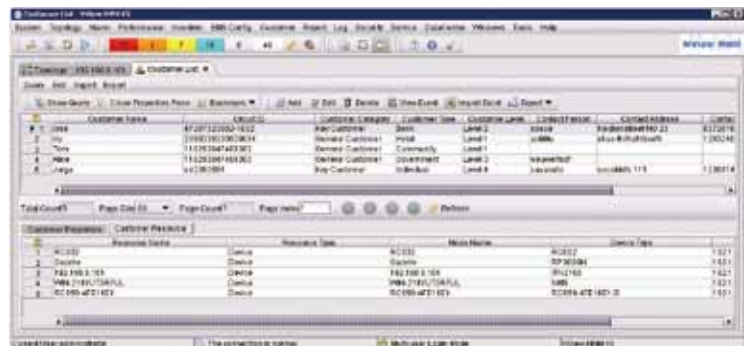

Performance Management

The NView NNM performance management function supports real-time monitoring of the SDH and Ethernet service performances to produce real-time as well as historical statistics for different periods. In addition, it also provides the basis for troubleshooting, fault speculation and network optimization.

- Uniform performance management system for all devices under management
- Tailored deployment for network of different capacity
- Monitor device CPU and RAM utilization
- Collect PON/Ethernet/UNI/SDH port current and historical performance data
- Performance graph based on performance data collected
- Performance data export
- Actual performance metrics based on ITU-T Y.1731/SLA
- Metric template management



Security Management

A number of user profiles and groups can be created in the security management module. However, only authorized users are allowed to login to the NView NNM system and operate it. This function protects all information on the system against illegal access, unauthorized use and other hazards.

- Multi-domain multi-authority management
- Different user profiles have different read and/or write authorities over devices in different subnets
- Client access control mechanism
- Unauthorized login deny mechanism
- Maintains system and device operation logs and supports log export

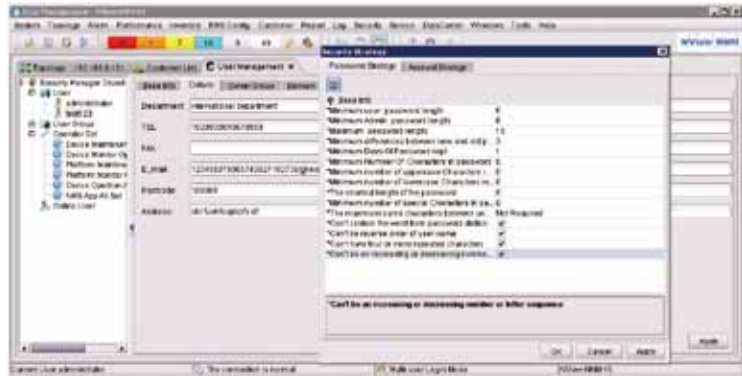

Web Management

Web management can help network operators to manage devices based on GUI interface via a web browser. It supports user management, configuration management, traffic statistics and devices status monitoring. Combined with Raisecom NView NNM system, it can also recognize fault management. All these functions can minimize overall operational costs and reduce provisioning times.

- User-friendly, intuitive graphical configuration interface
- Operator authorization levels
- Unauthorized login deny mechanism
- Synchronization mechanism ensuring real-time status update of the devices



Zero Touch Provisioning

In modern Carrier Ethernet networks, providers must consider a cross-functional automation that efficiently integrates commissioning, activation, inventory, fault, performance and network management. The challenging combination of the above capabilities is required for ensuring prompt new services launching, highly scalable network, effortless equipment roll-out and highest maintenance. In order to achieve such a level of automation, providers require an accurate and granular performance monitoring mechanism, combined with a fully-automated activation system.

Zero touch provisioning allows service-providers

to facilitate remote devices automatically without manual intervention. When remote devices are physically connected to the network and booted, the initial management IP can be automatically distributed to remote devices based on DHCP. When this occurs, the configuration and software updates can be automatically loaded into remote devices via a service template to perform a simple deployment minimizing human errors.

This mechanism ensures lean TCO and therefore guarantees the modernization of packet networks.

- Simple procedure: Rack, connect and power on
- Diverse and editable service templates
- Topology auto-discovery mechanism
- Physical and logical graphic representation of links and nodes

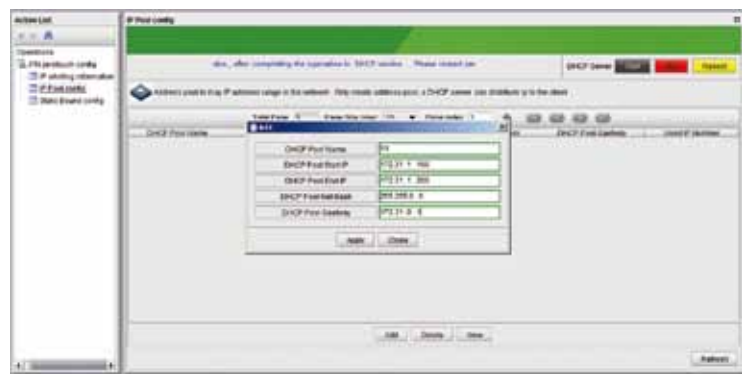

SLA Portal

CEview is a SLA portal that provides effortless massive deployment and service activation. CEview is able to handle all of the remote configuration done by NOC once devices are powering-on devices, and it is able to automatically generate and distribute configuration files in batch. SLA portal provides various ways to real-time monitoring performance data that is collected from probes, includes of web client and APP client installed on the IOS or Android system.

In addition, an upper-level NMS/OSS/BSS can share data and results on the NView NNM system through the northbound interface. The system also provides a disaster recovery solution, protecting the server from critical disasters and ensuring continuous running of the system by setting up a backup server and keeping it constantly synchronized with the main one.

In addition, SLA portal provides real-time monitoring to the devices performances collected from probes, and displays results from web client or IOS/Android smart phone APP client. Customer can export the performance report from smart phone.

The Raisecom SLA portal makes it simple for providers to optimize their network management. The easy management and monitoring result in a reduced workload. In addition, the simple operation and visual reports provide an improved service monitoring experience for customers.

- SLA KPI collection: Support collection of FD, IFDV, FLR, Bandwidth, Bandwidth Utilization
- Graphs: History and Real time display
- Export report: Support exporting history and Real time report
- Alarm: KPI exceed threshold, Device offline
- Logo: Customized Logo
- MAP: Support Google map
- WEB client: https, support IE10+/Firefox/Chrome/Safari browsers
- APPs: IOS, Android
- Capacity: 1000 total, 200 online, 20 concurrency

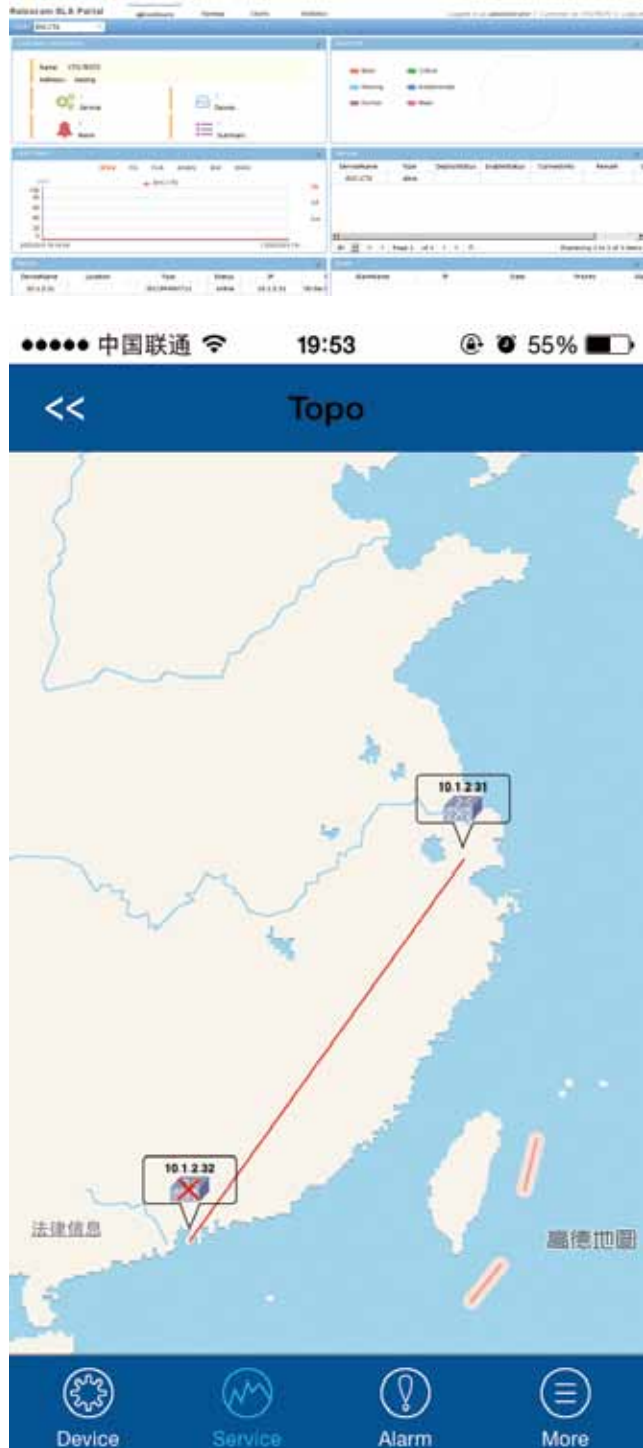

RAISECOM

www.raisecom.com

Raisecom Global Presence

International Headquarters, **Raisecom Technology CO., LTD.**

East-11, Raisecom Building, No.10 Xibeiwang East Road, Haidian District, Beijing, China, 100094

Tel.: +86 10 8288 3305 Fax.: +86 10 8288 3056

Email: jiyanding@raisecom.com www.raisecom.com

North American Headquarters, **Raisecom Inc.**

3031 N. Rocky Point Drive West, Suite 100 Tampa, Florida 33607 USA

Tel: +1 888 816 4808

Email: sales@raisecominc.com

Overseas Business Development Center

Rapaport St. Kfar Saba, Israel, 4465141

Tel.: +972 9 771 15 05

Email: info-obdc@raisecom.com

Overseas Branches

Indonesia Rep. Office (Jakarta): info-indonesia@raisecom.com

Thailand Rep. Office (Bangkok): info-thailand@raisecom.com

India Rep. Office (Mumbai): info-india@raisecom.com

Russia Rep. Office (Moscow): info-FSU@raisecom.com, info-russia@raisecom.com

Germany Rep. Office (Frankfurt): info-germany@raisecom.com

France Rep. Office (Paris): info-france@raisecom.com

Brazil Rep. Office (Sao Paulo): info-brazil@raisecom.com

Nigeria Rep. Office (Lagos): info-africa@raisecom.com

